



Newland

SCANNING MADE SIMPLE



NQuire 1000 Manta micro kiosk user guide

Revision History

Version	Description	Date
V0.1	Initial release.	August 4 th , 2016
V0.2	Fine-tuned for NQuire1000 specific features	January 5 th , 2017
V0.3	1) Revised home page 2) Added hardware & accessory installation & operation	January 31 st , 2017
V1.0	Updated all the screenshots.	November 23, 2018
V1.1	Updated the “12. Control I/O Ports & Cover” section.	January 8, 2019
V1.2	Updated the “Installation & Operation” section.	April 4, 2019

Table of Content

Disclaimer	4
Device Instruction & Installation	5
Hardware Instruction.....	5
1. LED Indicator	6
2. SD Card Slot / Cover	6
3/4/5. Push Buttons.....	7
7. Expansion Slots & Add-on modules	7
8. Speaker.....	8
9. Vesa Mount Holes.....	8
10. DC-In Jack	9
11. Barcode Scanner	9
12. Control I/O Ports & Cover	9
13. Generic I/O Port Covers.....	12
14/15/16 Generic I/O Ports	13
17. Power Switch	13
18. Headphone Audio Jack.....	13
Accessory & Installation	14
VESA Wall Mount	14
Installation & Operation.....	14
Feature Programming.....	15
Home Screen.....	15
Change Wallpaper	15
Add Widgets.....	18
System Bar	20
Navigation Buttons.....	20
Status Notifications	21
Applications.....	22
Language & Input Method	23
Date & Time.....	24
Volume.....	25
Brightness.....	26
Schedule Power On/Off.....	27
Wi-Fi.....	29
Ethernet	29

Bluetooth.....	31
Virtual Keyboard	32
Take Photos.....	34
Surf Online.....	35
Browse Files	36
Play Media	37
Install & Uninstall Apps.....	38
Install Apps.....	38
Uninstall Apps	41
Reset to Factory Default.....	43

Disclaimer

- ✓ Please read the instructions carefully before equipment installation and using the device.
- ✓ Do not put the product in high temperature, humid or dusty environment.
- ✓ Do not drop, crash or break down this product.
- ✓ Do not power off the device when it's formatting or upgrading, otherwise it will cause operation system error.
- ✓ This product is IP54 certified in waterproof and dustproof on front panel (only).
- ✓ Use only approved add-on enhancements.

Device Instruction & Installation

Hardware Instruction

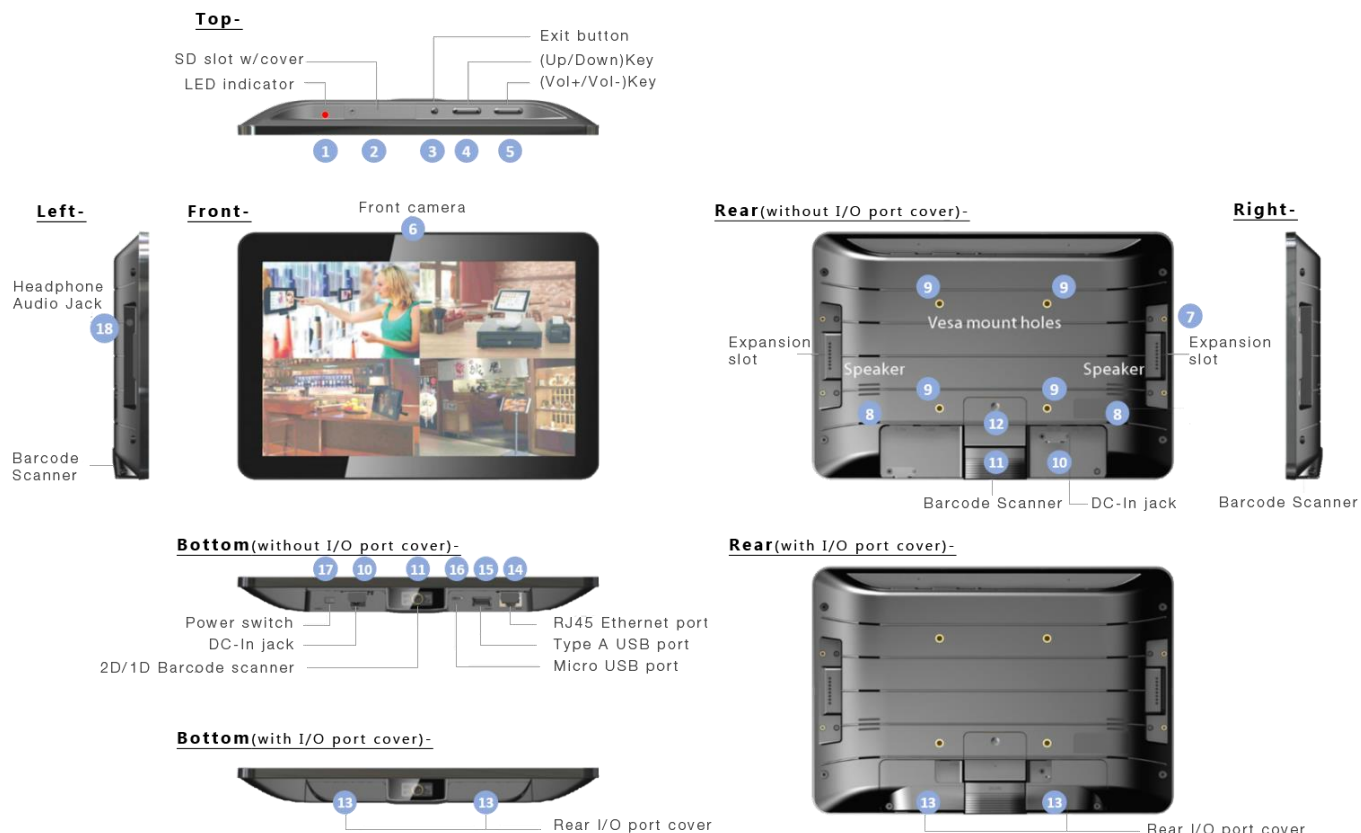

1. **LED Indicator**
2. **SD Card Slot / Cover:** support external SD card
3. **Exit Button:** return to the previous page
4. **Up / Down Buttons:** navigate up/down to select an item
5. **Vol+ / Vol- Buttons:** adjust the system volume
6. **Front Camera:** embedded 2M pixels (& 5MP or 8MP) optional
7. **Expansion Slot:** install optional add-on modules
8. **Speakers:** dual audio output
9. **VESA75 Mounting Holes:** max. screw depth 4.5mm from mounting surface
10. **DC-In Jack:** powered by 12V/2A DC input
11. **Barcode Scanner:** 2D barcode scanner to scan barcode
12. **Control I/O Port Cover:** cover for GPIO and RS-232 ports
13. **Generic I/O Port Covers (left and right pieces):** cover for frequently used I/O ports

- 14. **10/100Mbps Ethernet Port:** RJ45 connector supporting Ethernet connection
- 15. **USB Host Port:** support USB 2.0 Host type A
- 16. **Micro-USB OTG Port:** USB 2.0, Micro-USB type B jack, OTG
- 17. **Power Switch:** switch power ON/OFF
- 18. **Headphone Audio Jack**

Hardware Instruction & Operations

(Installation & Uninstallation)

1. LED Indicator

Red	Power supply is on.
Light Off	Power supply is off.

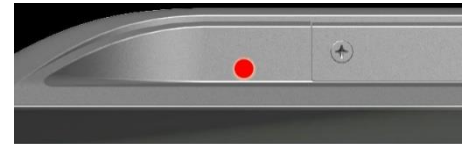

2. SD Card Slot / Cover

Support external SD card up to 32GB (/ 64GB)

INSTALLATION:

- 1) Release the screw on SD card cover
- 2) Remove SD card cover
- 3) Insert SD card into the push-push SD card slot



REMOVAL:

- 1) Push SD card inside the slot, release press force suddenly to let SD card popped out from the slot
- 2) Insert cover and fix it by screw

3/4/5. Push Buttons

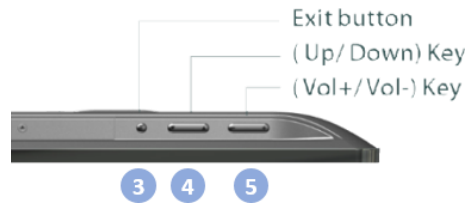

7. Expansion Slots & Add-on modules

For add-on modules like existing barcode scanner, MSR and NFC.



ADD-ON MODULES



INSTALLATION

1. Align the positioning bumps on module with the pits on main device and gently press down until they are fully inserted.
2. Fix module on main device by screws*.



*the torque of the screws for modules (LTE1000V2, MSR1000V2, LF1000V2 & NFC1000V2) is **0,4 N·m**

8. Speaker

Dual audio output.



9. Vesa Mount Holes



10. DC-In Jack

Plug the power adapter into the power jack, and fix the position by a small metal bracket to prevent it from loosening.



11. Barcode Scanner

Barcode engine is set up in auto mode as default setting. LED will light up when any object shows in front of barcode scanner within proper distance, and barcode engine will automatically scan when a barcode showed within proper distance.



12. Control I/O Ports & Cover

There are control IO ports (RS-232 & GPIO) under the Control IO cover (#12 in Device Instruction). Press the cover to slide backward to open the cover, or slide forward to close the cover.

RS-232 port pinout (PIN1-PIN6):
GND, RX, TX, GND, 5V, 5V.

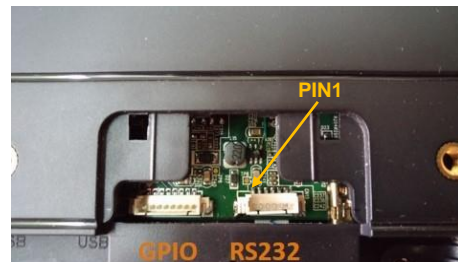

GPIO port pinout (PIN1-PIN8): INPU_VOD (GPIO0_31), INPU_VOC (GPIO0_30), VOB_OUT (GPIO0_29), VOA_OUT (GPIO0_15), INPUT_GND, INPUT_GND, N/A, INPUT_VCC_In.

The NQquire can be connected to devices, such as LED lamp, door lock or access control system via its GPIO port.

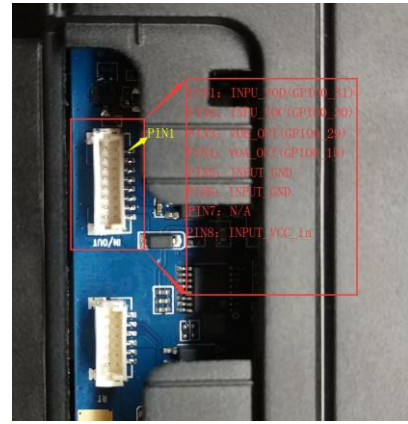

Call the NQquire's GPIO control API: Reference

nq1000_interface_api.jar and then import com.android.nq1000.NQManager in your code.

Introduction to the NQManager class:

API	Description	Parameters	Type of Return Value	Return Value
setdoorThreshold (String value)	Set GPIO pin state	150: Set VOA_OUT (GPIO0_15) to high 151: Set VOA_OUT (GPIO0_15) to low 290: Set VOB_OUT (GPIO0_29) to high 291: Set VOB_OUT (GPIO0_29) to low 1011: Enable UART 1010: Disable UART	boolean	true: success false: failure
getdoorData()	Read the state of INPU_VOC (GPIO0_30) and INPU_VOD (GPIO0_31)	Null	String	00: GPIO0_30 high, GPIO0_31 high 01: GPIO0_30 high, GPIO0_31 low 10: GPIO0_30 low, GPIO0_31 high 11: GPIO0_30 low, GPIO0_31 low

GPO circuit example:

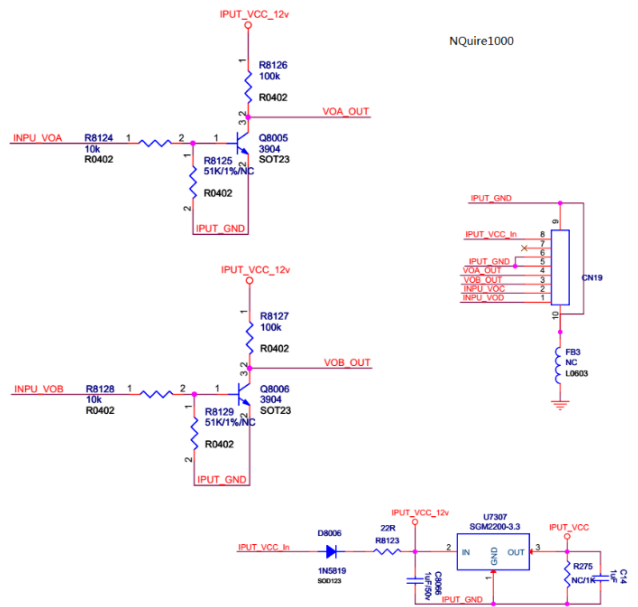

GPI circuit example:

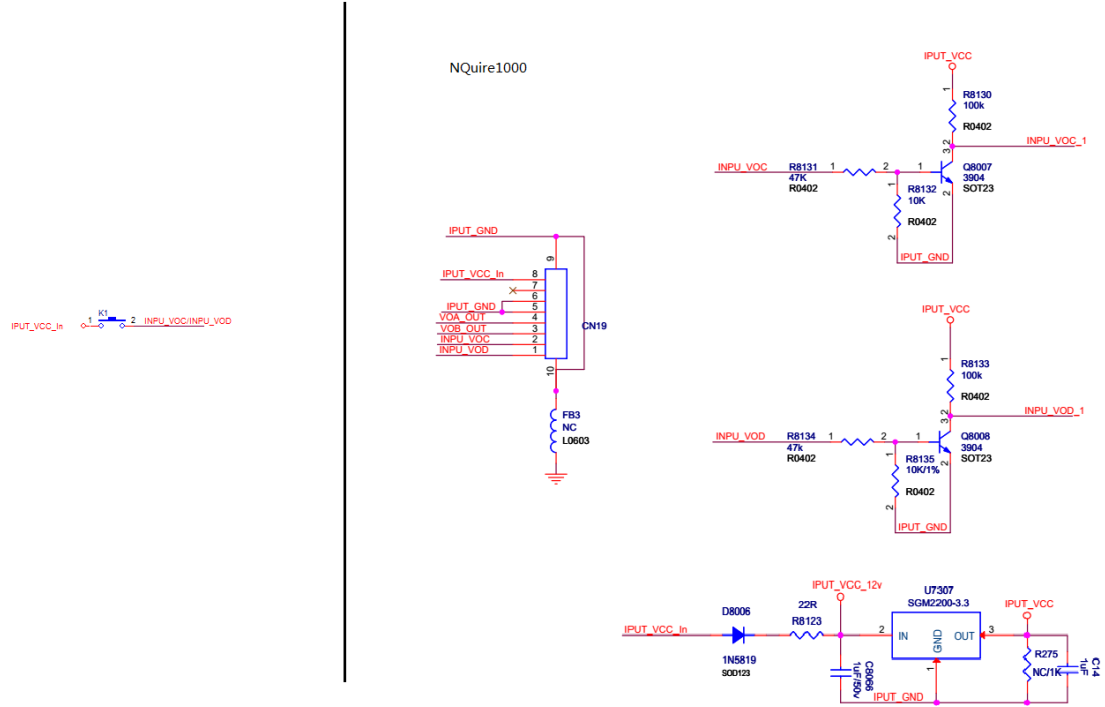

Control logics:

NET NAME	CONDITION	RESULT	REMARK
INPU_VOC	INPU_VOC=IPUT_VCC_In	GPIO0_30=L	INPUT
	INPU_VOC=IPUT_GND	GPIO0_30=H	
INPU_VOD	INPU_VOD=IPUT_VCC_In	GPIO0_31=L	
	INPU_VOD=IPUT_GND	GPIO0_31=H	
VOA_OUT	GPIO0_15=H	VOA_OUT=IPUT_GND	OUTPUT
	GPIO0_15=L	VOA_OUT=IPUT_VCC_In	
VOB_OUT	GPIO0_29=H	VOB_OUT=IPUT_GND	
	GPIO0_29=L	VOB_OUT=IPUT_VCC_In	

Electrical requirements:

$$12V \leq \text{IPUT_VCC_In} / \text{INPU_VOC} / \text{INPU_VOD} \leq 24V$$

13. Generic I/O Port Covers

ANALYSIS OF STRUCTURE

Covers for right cabinet and left cabinet.

INSTALLATION

- 1) Put the hook on plastic cover into the hook
- 2) Level the plastic cover.
- 3) Pushing cover forward, let positioning tenon into the positioning groove on main device.
- 4) Tighten screw to fix the cover.

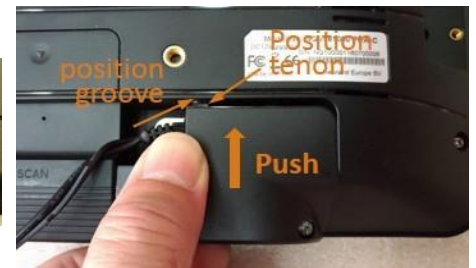

REMOVAL

- 1) Loosen screw to release the cover. It is recommended not to pull screw out completely to prevent it from being lost.
- 2) Pull cover backward horizontally.
- 3) Pull up the front end of cover to remove cover.



SCENARIO

1) With both covers fixed and cables



2) Without both covers, with cables



14/15/16 Generic I/O Ports

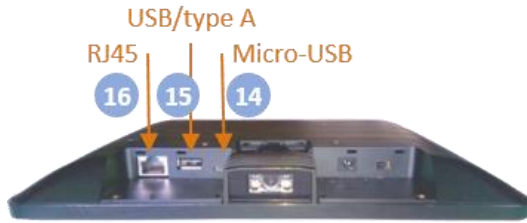

17. Power Switch

- 1) Switch on to boot up device.
- 2) By default, power switch is in **ON** position.



18. Headphone Audio Jack



Accessory & Installation

VESA Wall Mount

Installation & Operation

1. Select a mounting location that is convenient for operation.
2. Remove the screw attaching the bracket to the chassis of The VESA 75 mount.
3. For wall mounting, install the four plastic wall anchors in a wall and then secure the bracket of VESA 75 mount to the wall using the four large screws. For countertop/shelf mounting, secure the bracket of VESA 75 mount to a countertop/shelf using the four large screws.
4. Complete all wire/cable connections to the NQuire. Secure the chassis of VESA 75 mount to the back of the NQuire using the four small screws. **Note that the depth of screw insertion into the NQuire must not exceed 4.5mm.**
5. Attach the bracket back to the chassis with the screw that was removed in step 2.

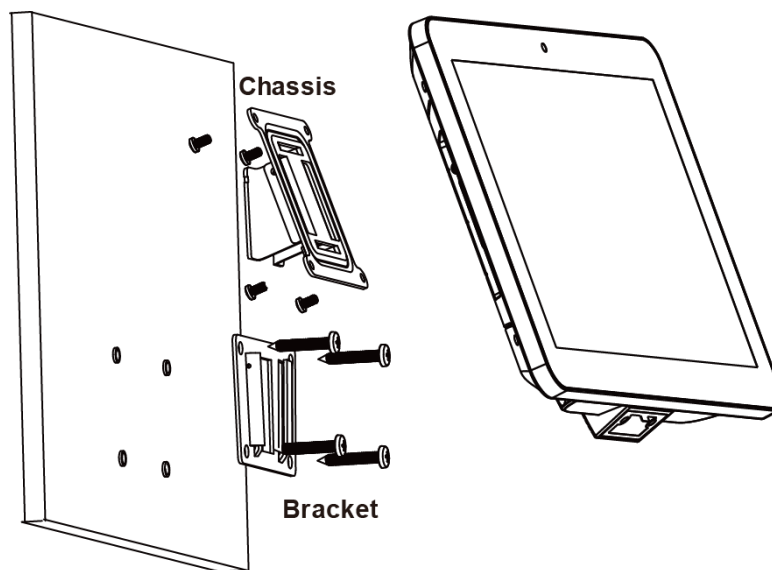

Feature Programming

Home Screen

On the home screen, you can long-tap on any blank area to change the wallpaper or drag widgets to desktop.

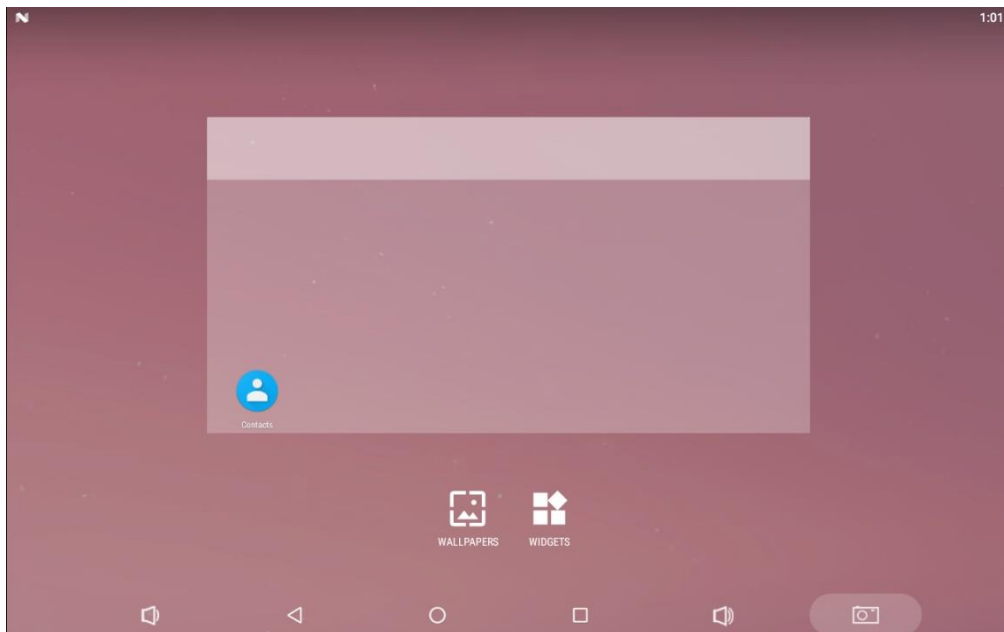

Change Wallpaper

1. Tap .

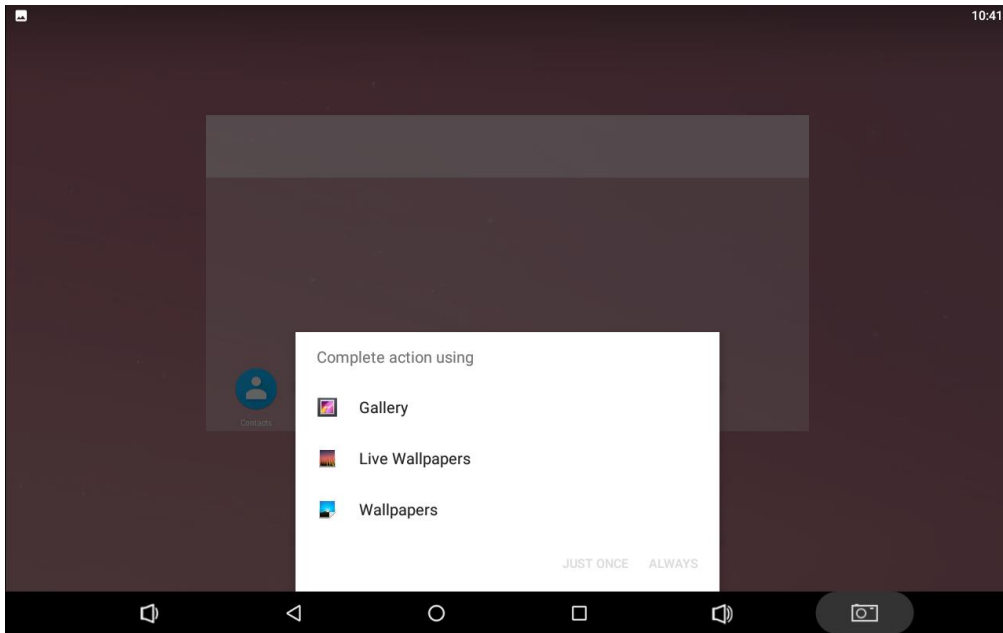

2. Tap **“Wallpapers”**.

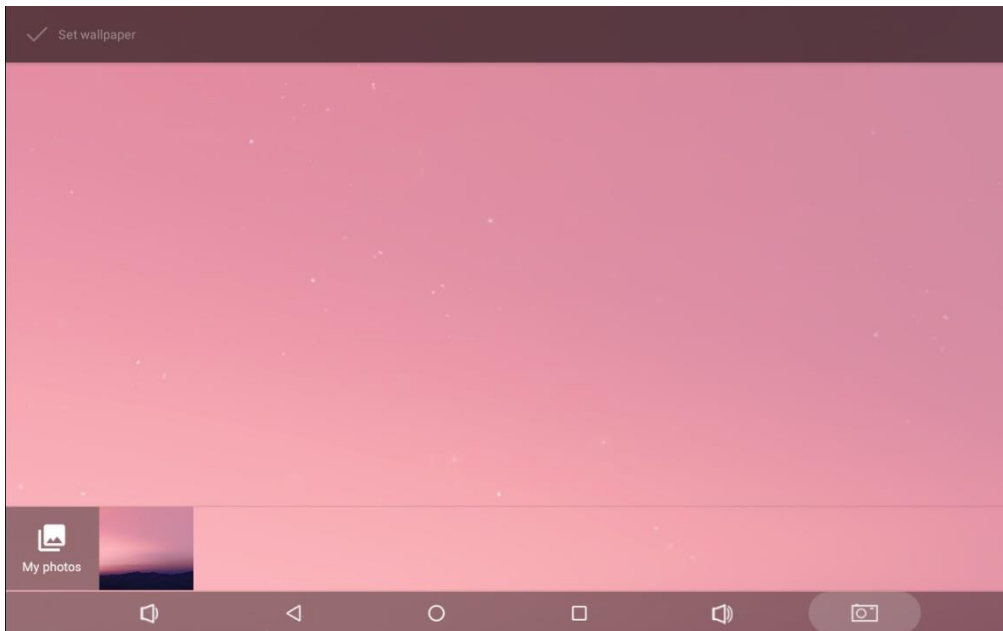

3. Select the image you want as your wallpaper.

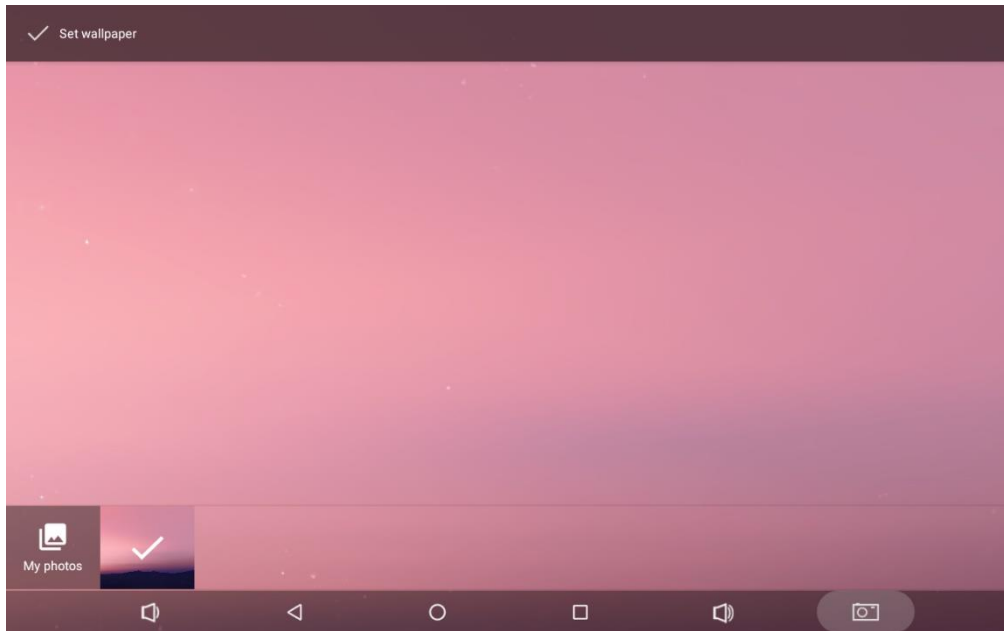

4. Tap **"Set wallpaper"** on the upper-left corner of the screen then **"Home screen"** to apply the new wallpaper.

Add Widgets

1. Tap .

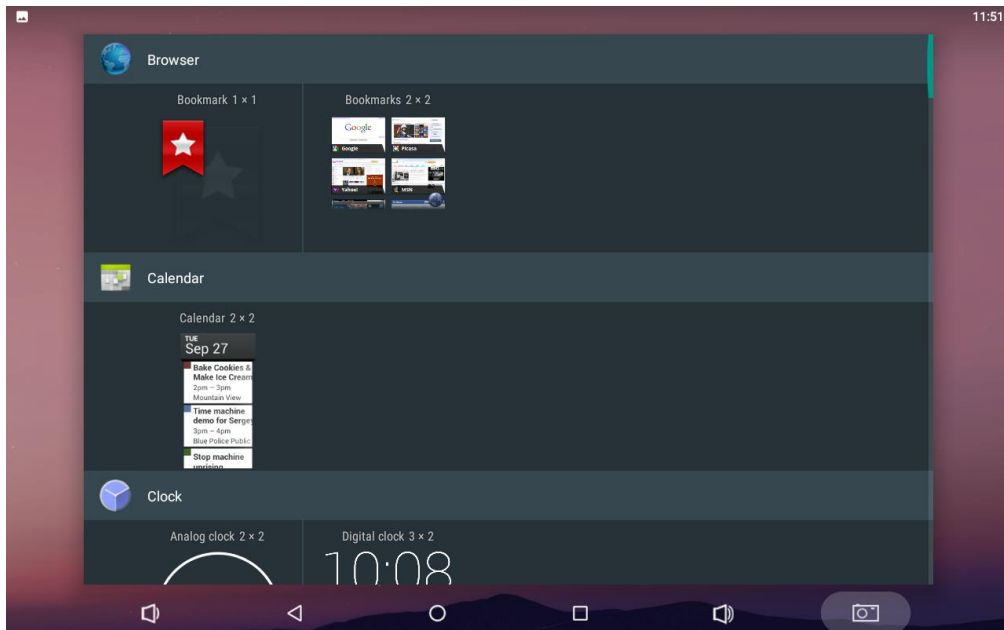

2. Long-tap on a widget and drag it to desktop.

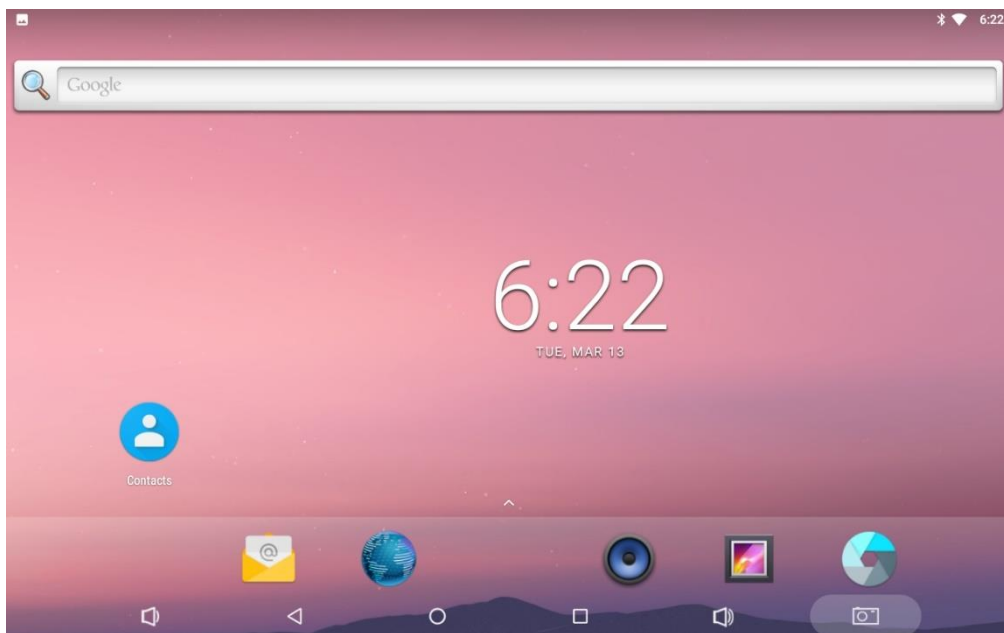

3. If you want to remove an icon, long-tap on the widget and then drag it onto “X Remove” at the top of the screen.

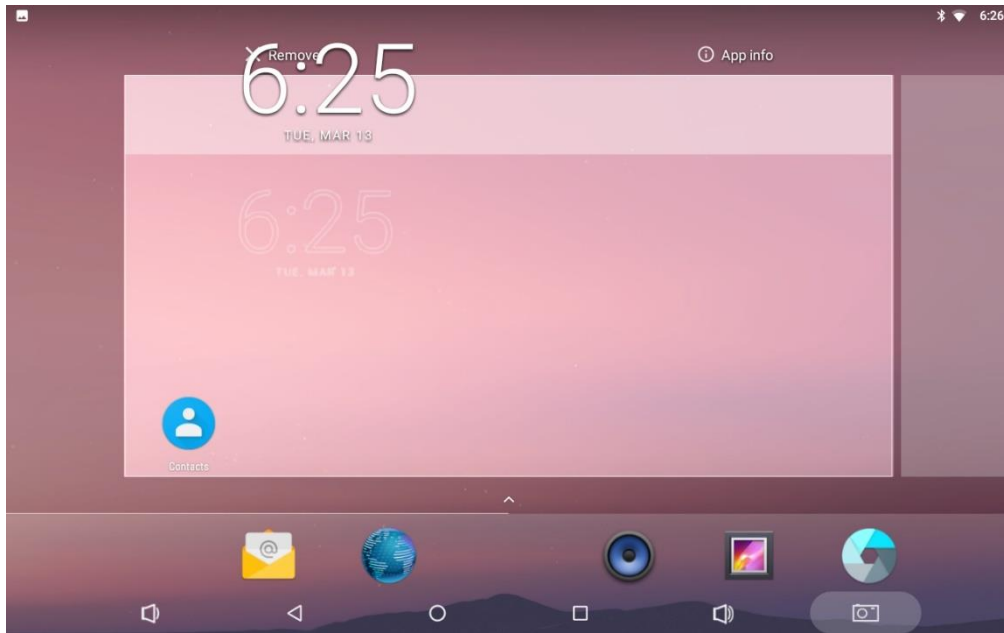

System Bar

Navigation Buttons



1 2 3 4 5 6

1. **Volume-**: Decrease the system volume.
2. **Back**: Return to the previous page.
3. **Home**: Return to the home screen.
4. **Recents**: Switch between recently used apps.

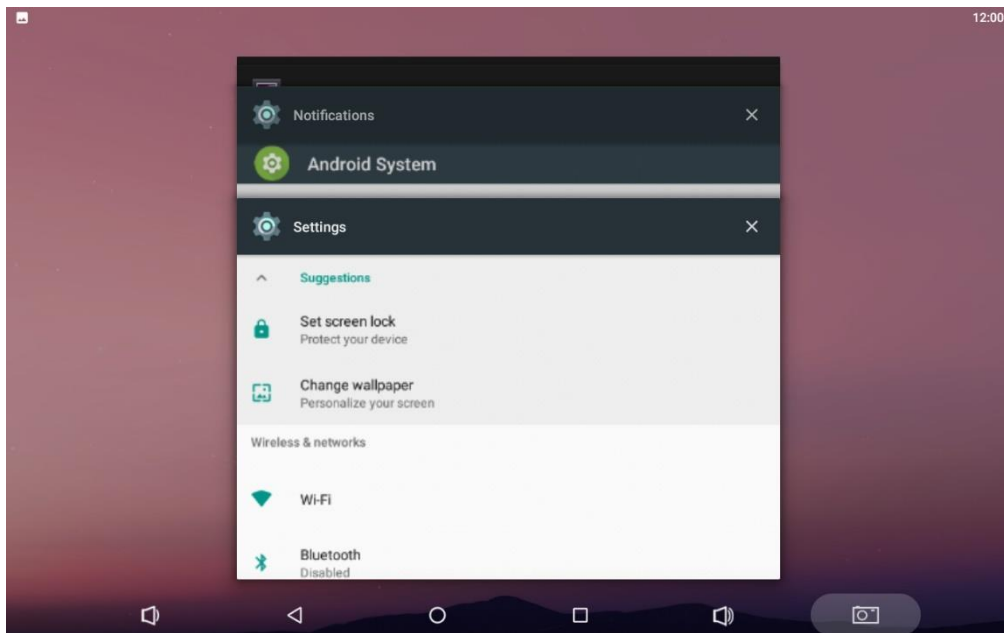

To remove an app from the list, swipe the app item left or right or tap “X” in the upper-right corner of the app window to remove it.

5. **Volume+**: Increase the system volume.

6. **Screenshot**: Take a screenshot.

Status Notifications



Status bar at the top of the screen displays system status, such as time, Wi-Fi, SD card and USB connection, etc.

Pull down the status bar to open the status window.

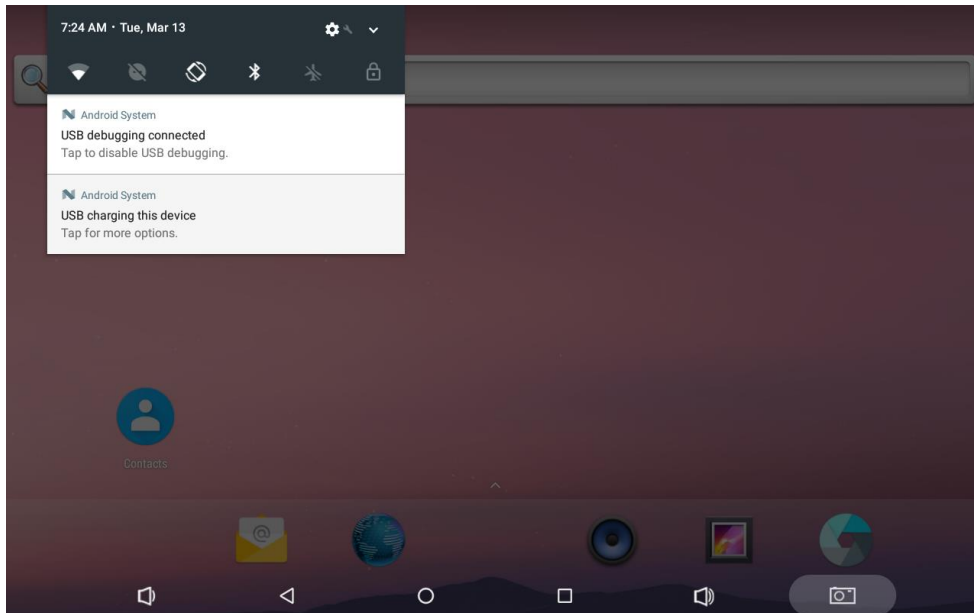

Pull down the status bar to open the shortcuts window which contains brightness adjustment, Wi-Fi, Do Not Disturb, auto rotate, Bluetooth, airplane mode, physical button and invert colors, and system settings entrance.

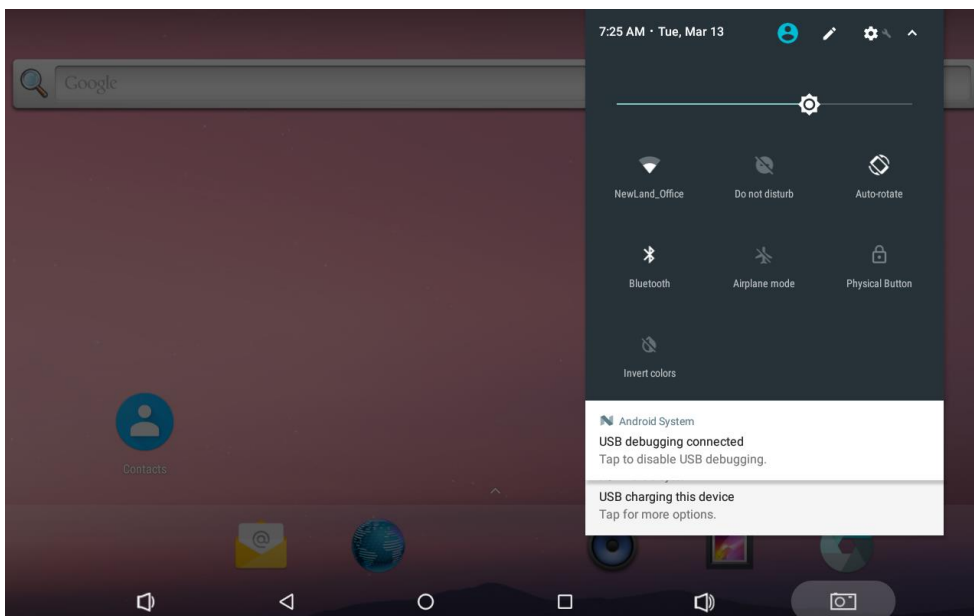

Applications

Tap \wedge above the app shortcuts on the home screen to view the App list.

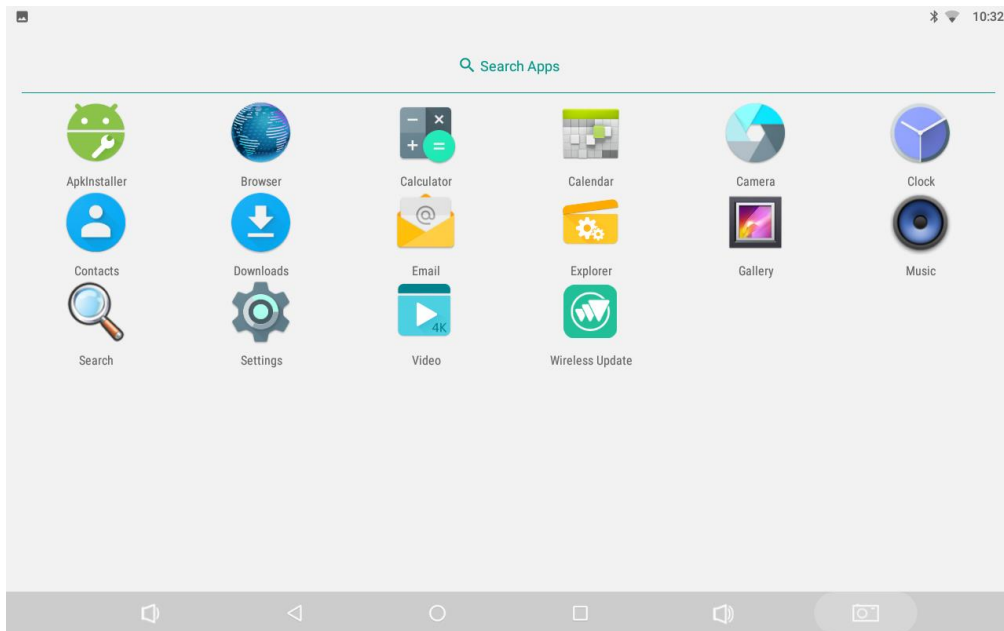

The installed applications will be shown here and you can open an app by tapping its icon. To find an app easily, you can create a shortcut by long-taping on the icon and dragging it into the home screen.

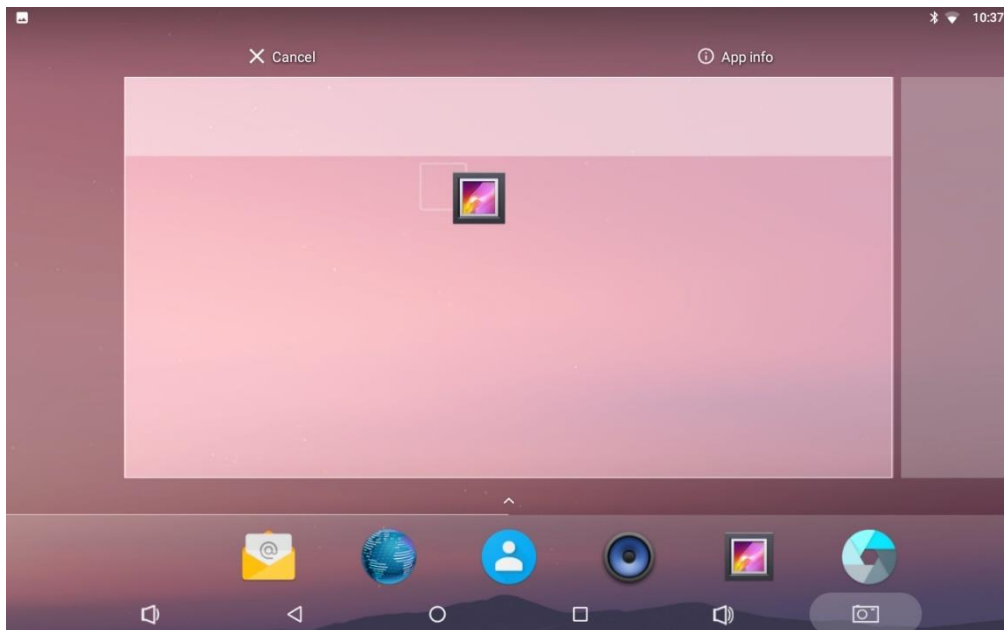

Language & Input Method

In the App list, tap “Settings”  to open the system settings app, and select “Language & input”.

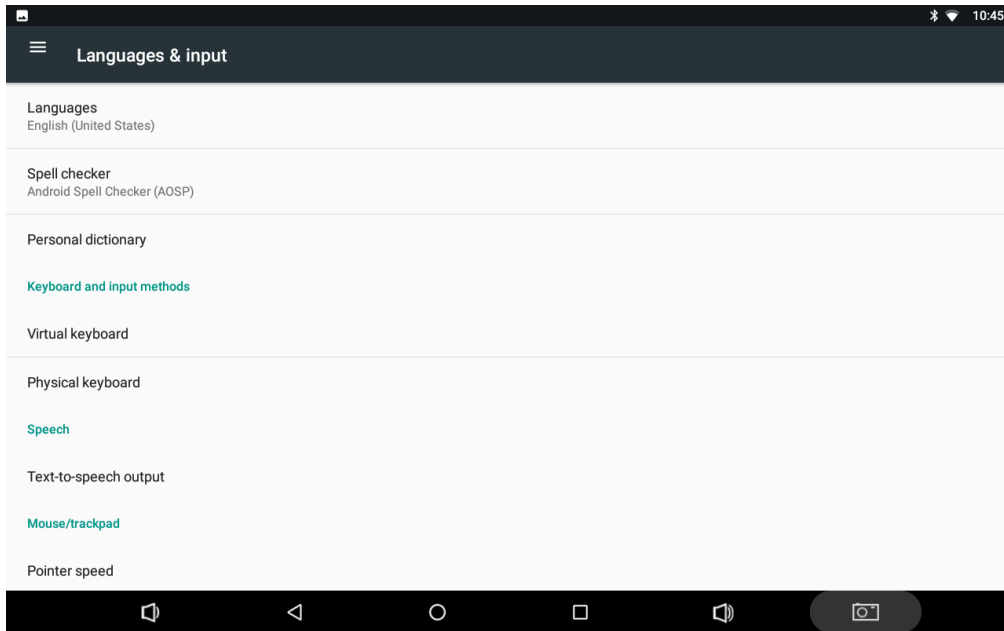

Change language: Tap “Language” then “Add a language”, and then you can change the system language according to your preference.

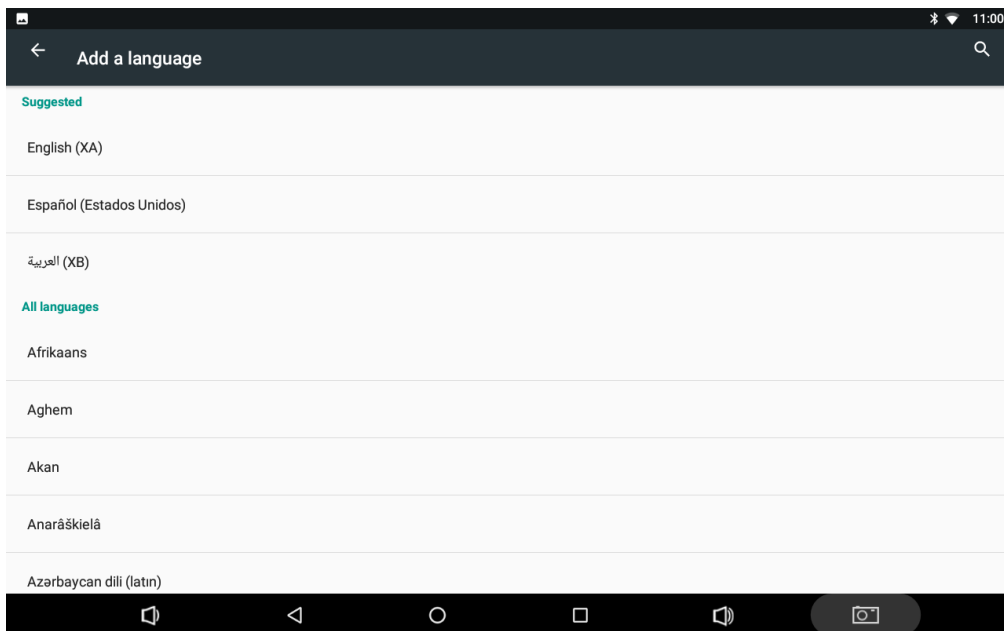

Enable an input method: Tap “Virtual keyboard” then “Manage keyboards”, and then enable the desired input method.

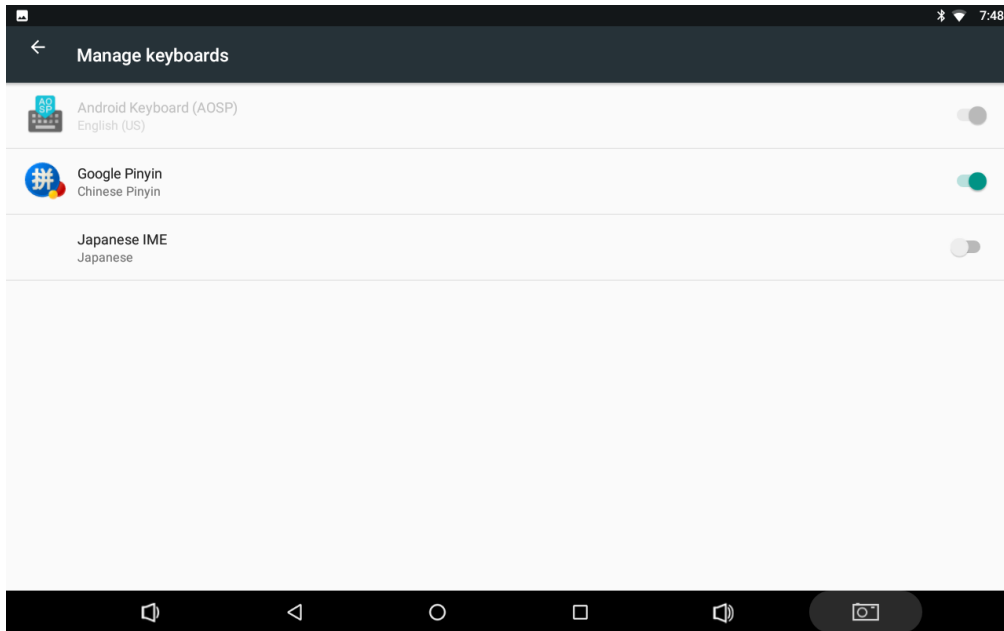

Date & Time

In the App list, tap “Settings”  to open the system settings app, and select “Date & time”.

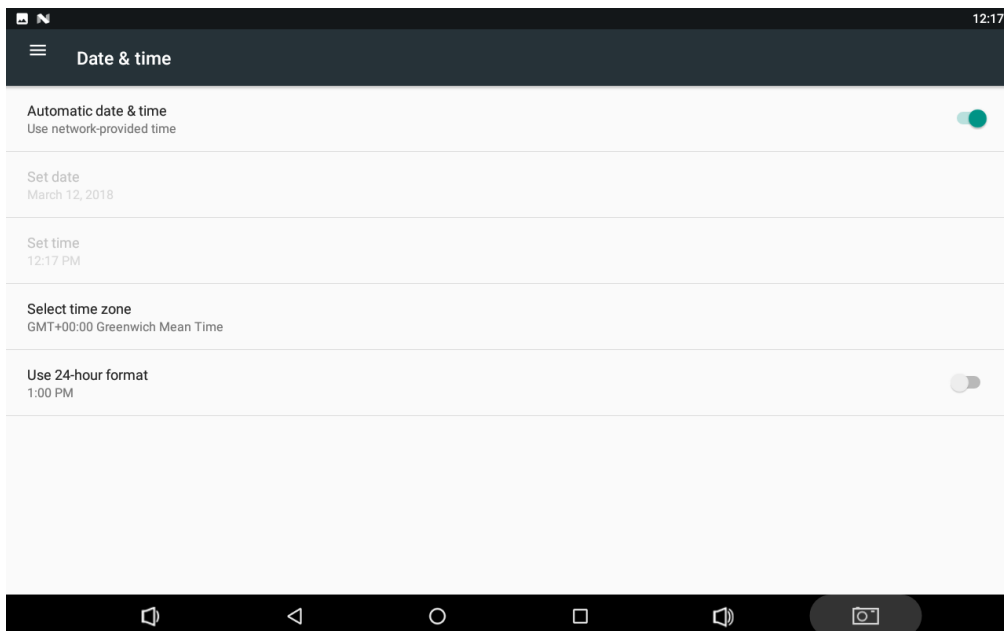

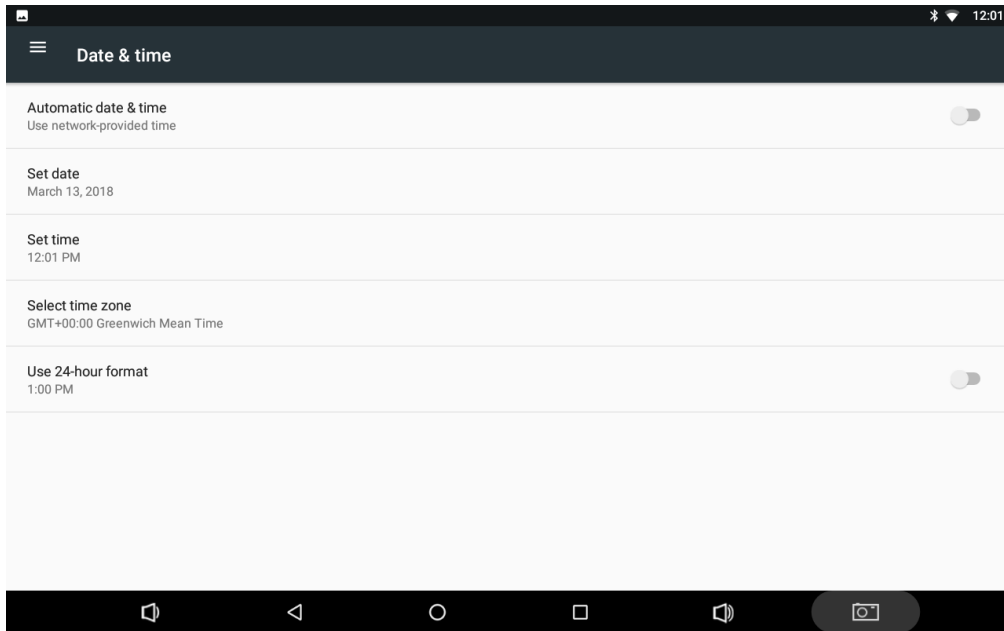

If the “**Automatic date & time**” option is enabled, system date and time will be synchronized automatically with network time when you connect your device to a Wi-Fi network.

To set the time manually, you need to disable “**Automatic date & time**”.



Besides, you can also set time zone and time format as per your needs.

Volume

On the system bar, click the **Volume-** icon  to decrease the system volume, and click the **Volume+** icon  to increase the system volume.

Or you can press the **Vol+ / Vol-** buttons (#5 in Device Instruction) on the top of the device to adjust the volume.

Brightness

In the App list, tap “**Settings**”  to open the system settings app, and select “**Display**”.

Tap “**Brightness level**” and then move the brightness slider to the left to decrease the brightness and right to increase it.

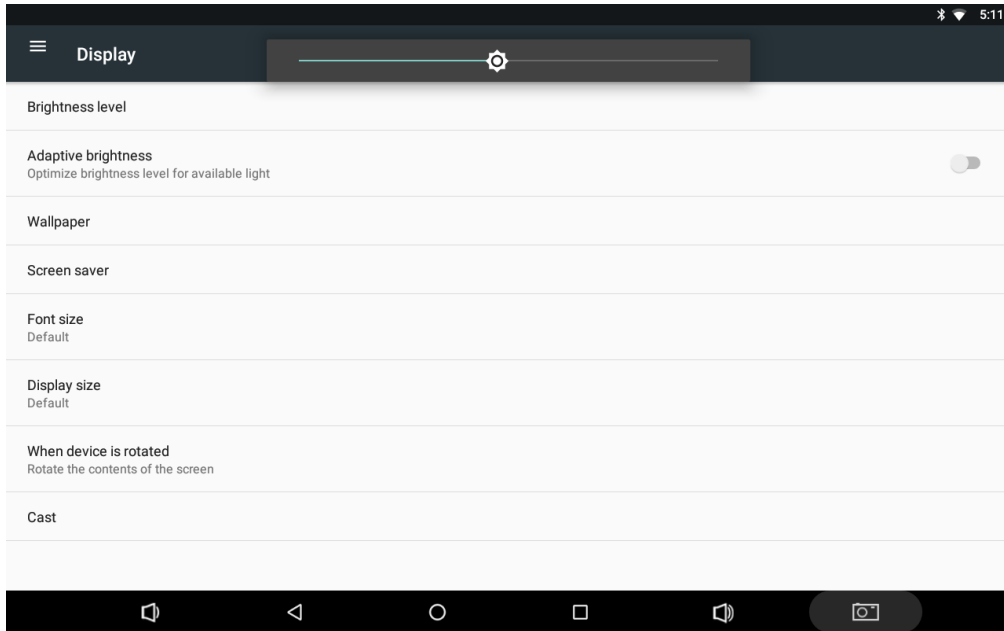

If you want the brightness to be adjusted automatically based on ambient lighting, enable the “**Adaptive brightness**” option.

Schedule Power On/Off

This function is used to power the device on and off automatically at a specific time each day.

In the App list, tap “**Settings**”  to open the system settings app, and select “**Time Screen**”.

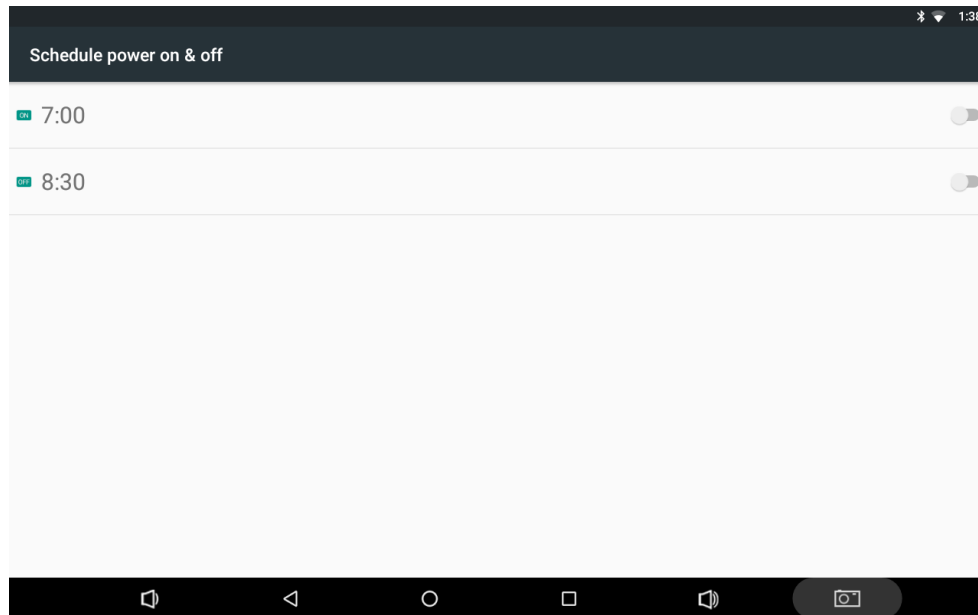

The top row is for power on clock, and the following row is for power off clock. To enter the power on/off clock settings, tap the corresponding row.

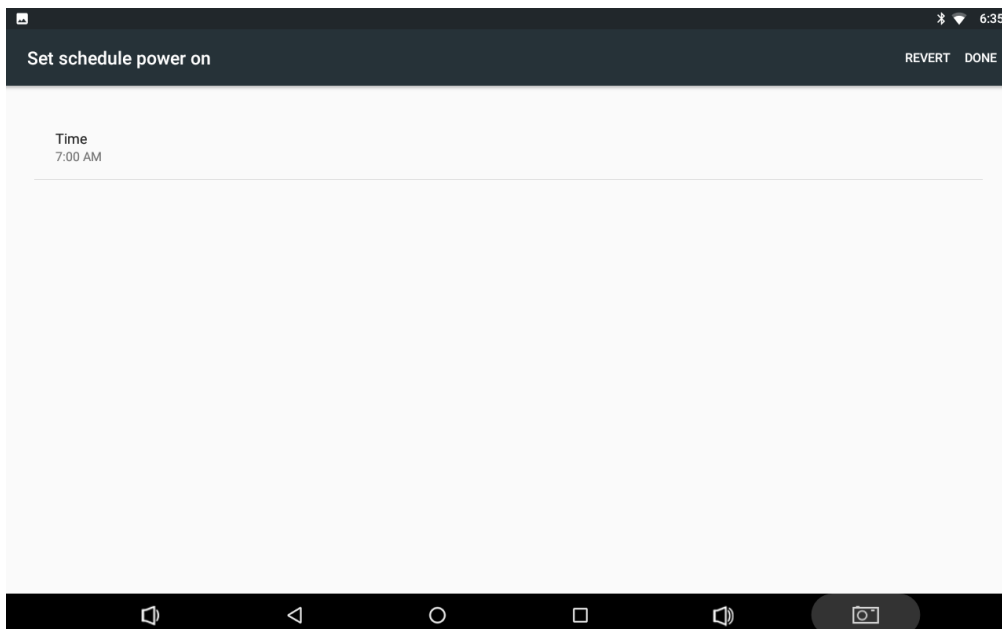

Tap **“Time”**. Then set the time and tap **“OK”**.

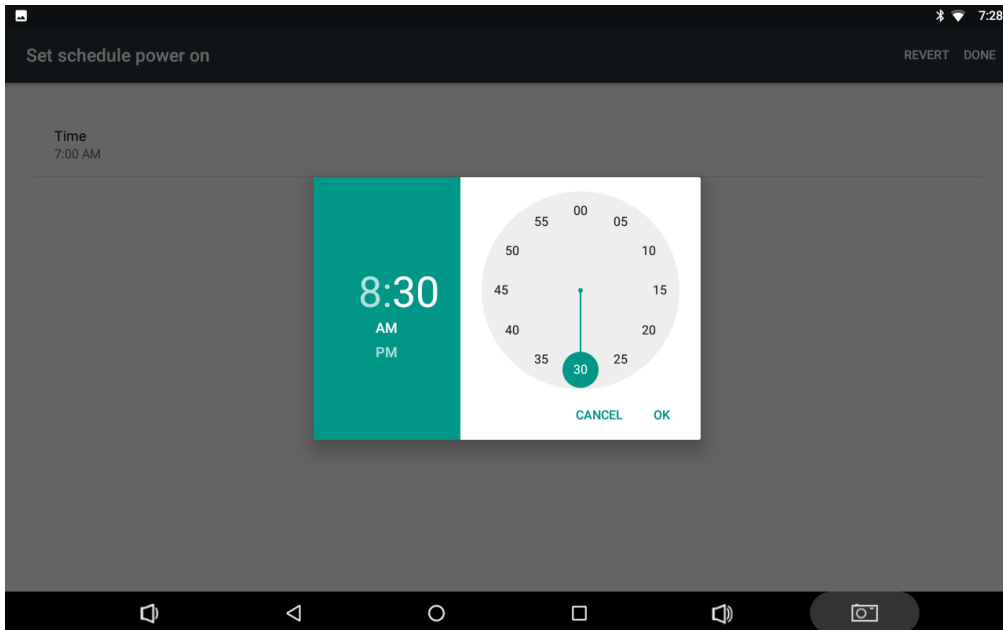

Tap **“DONE”** at the upper-right corner of the screen to save the setting.

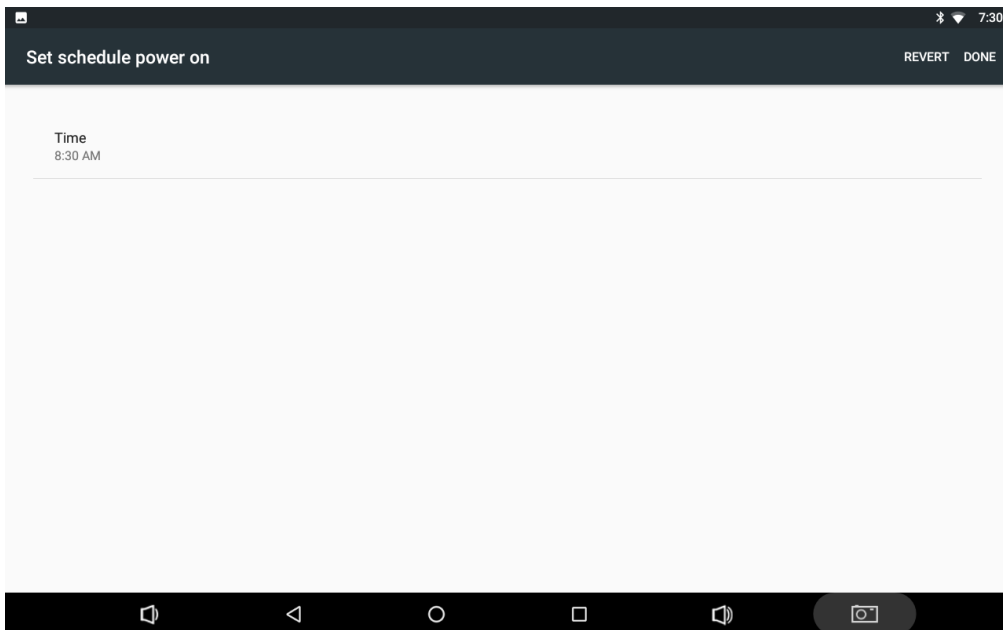

Wi-Fi

Join a Wi-Fi network: In App list, tap “**Settings**”  to open system settings app, and select “**Wi-Fi**”. Turn Wi-Fi on to find available Wi-Fi networks. Select a network and enter the password, then tap “**CONNECT**”.

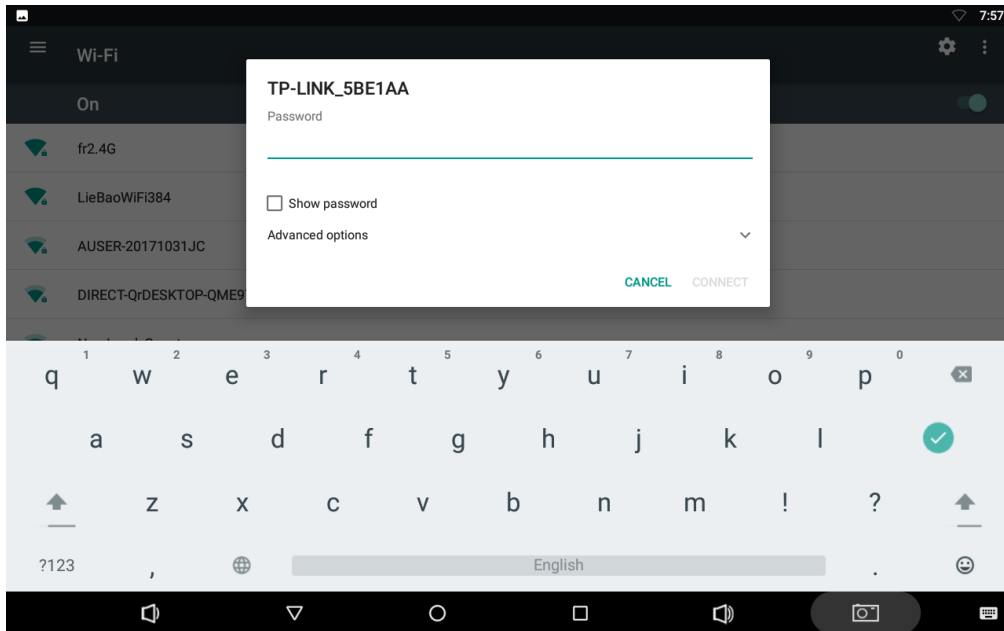

Ethernet

Be sure to turn off Wi-Fi if you want to connect your device to the Internet through Ethernet. Plug the Ethernet cable into your device’s Ethernet port (#14 in Device Instruction).

In the App list, tap “**Settings**”  to open the system settings app, and select “**More**”. Tap “**Ethernet**”.

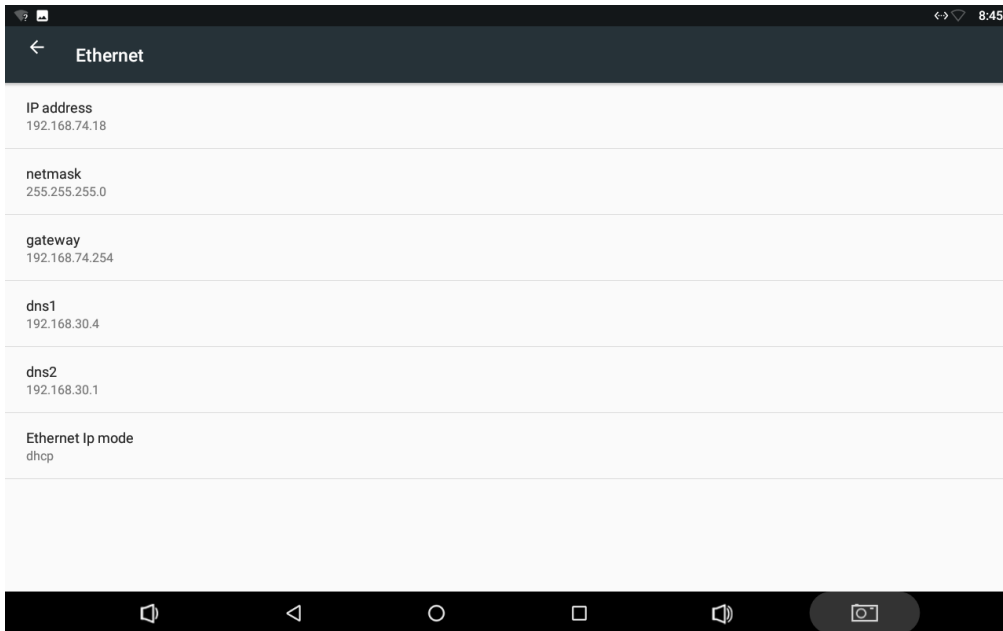

If you want to specify a static IP address for your device, tap “**Ethernet Ip mode**” then “**static**”, and enter the IP address, gateway, netmask and DNS server. Tap “**CONNECT**”.

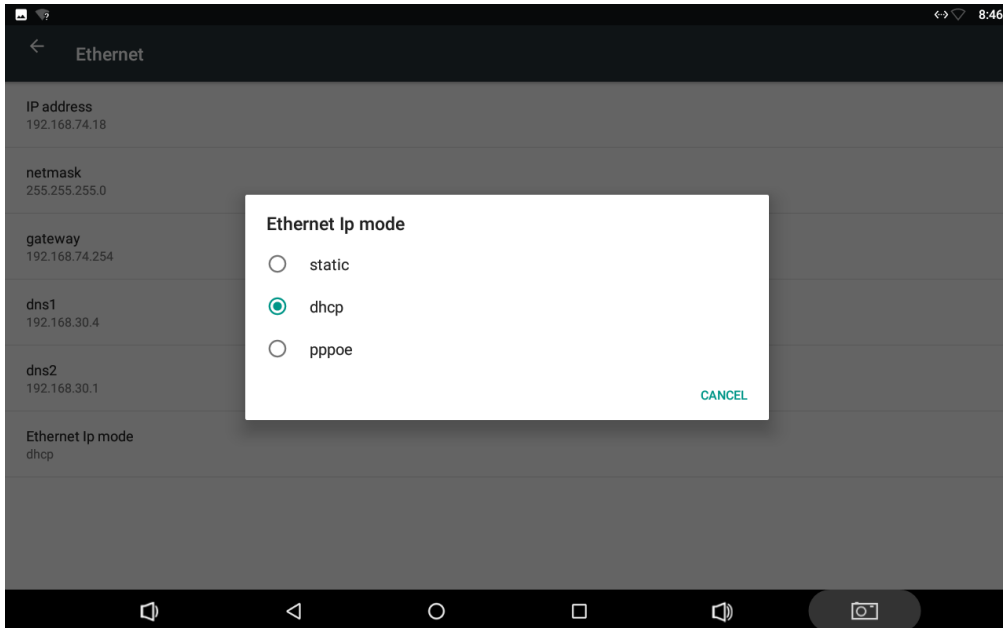

Bluetooth

You can set up a Bluetooth connection between the device and other Bluetooth devices, such as PC, mobile phone. Note that Bluetooth connection works better if there are no obstacles between them.

Pair your device to a Bluetooth device: In the App list, tap **“Settings”**  to open the system settings app, and select **“Bluetooth”**. Turn Bluetooth on to search for available Bluetooth devices. Select the desired device from the search results and then tap **“PAIR”**.

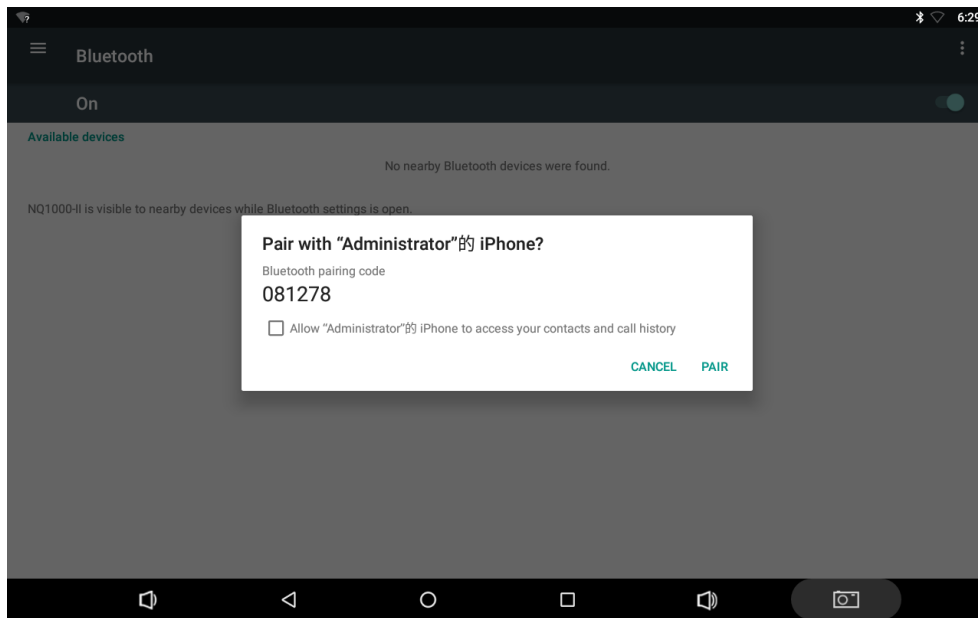

After pairing, the paired device will be moved to the “Paired Devices” list.

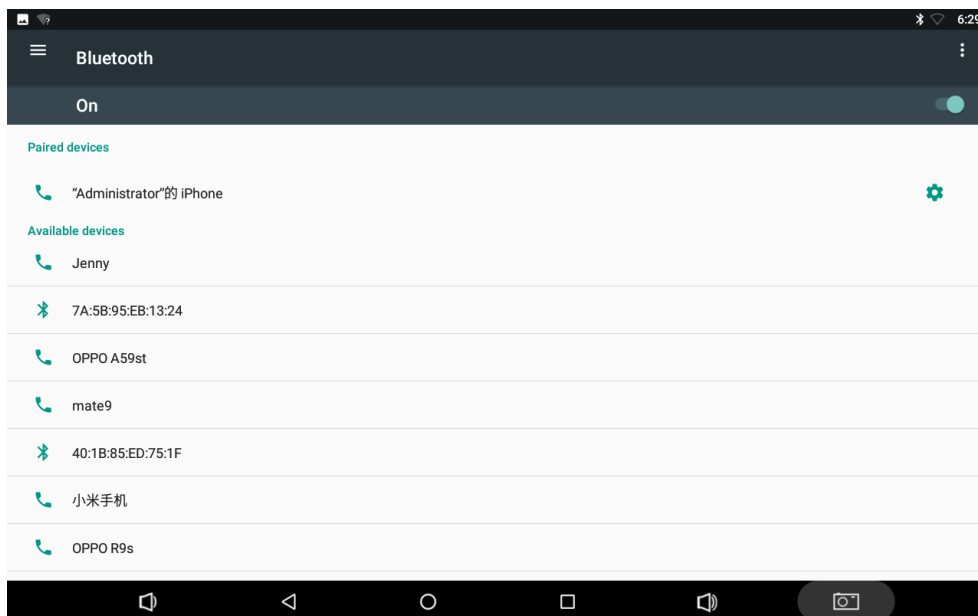



Virtual Keyboard

The device provides a virtual keyboard for typing. You can use it as a real one.

When you tap a text input field, the virtual keyboard will appear at the bottom of the screen.

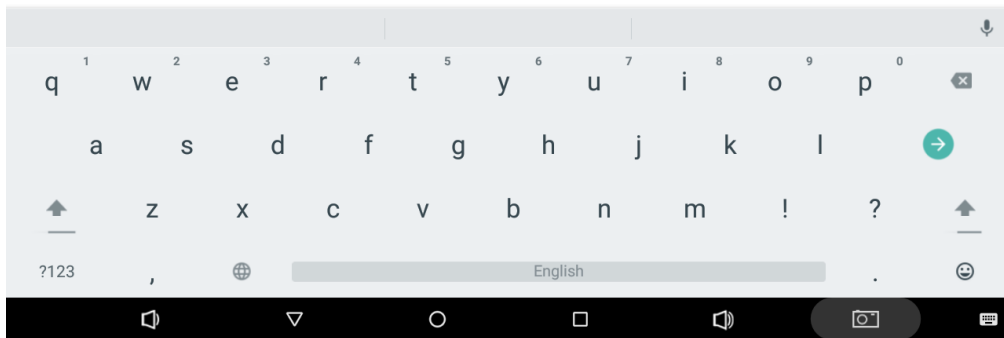
To close the virtual keyboard, you can tap  in the system bar at the bottom of the screen.



Change keyboard: Tap  in the lower-right corner of the screen, and then select the desired keyboard from the pop-up window.

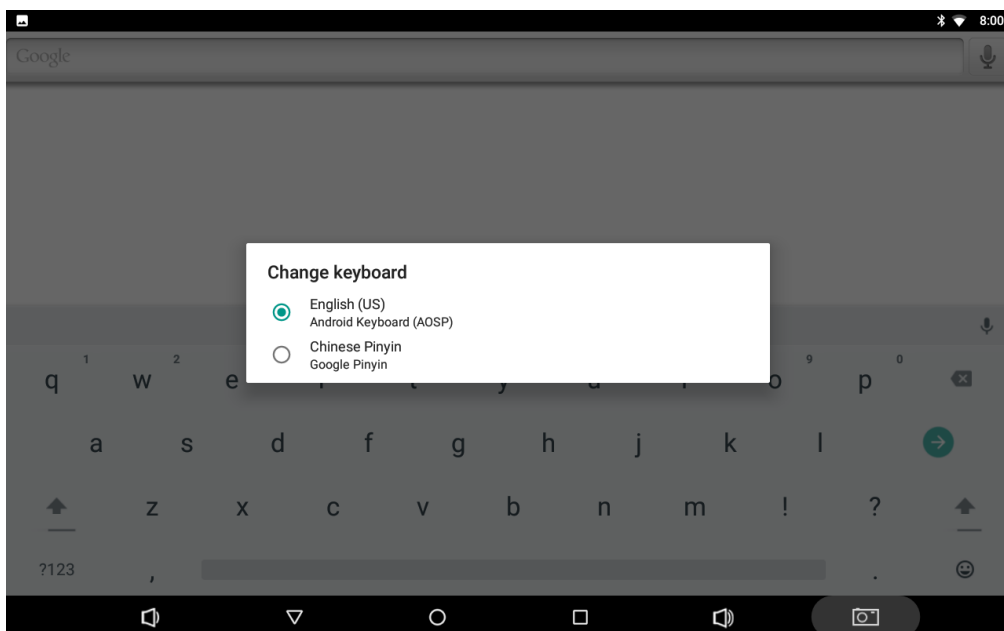

If the keyboard icon  is not present in the system bar, go to **Settings > Languages & input > Virtual keyboard > Manage keyboards** > enable the input method(s) you want to use.

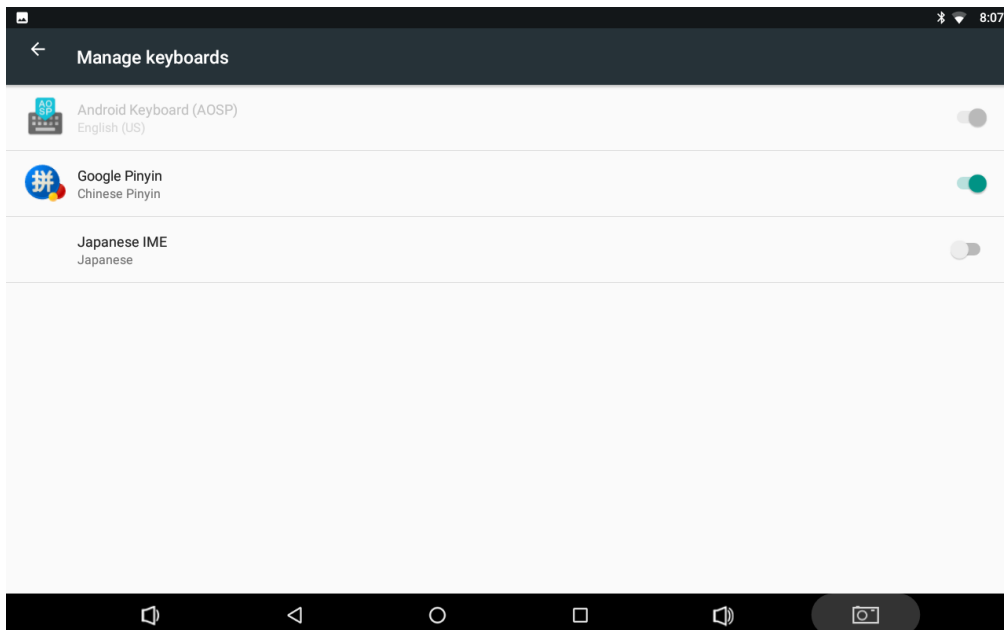
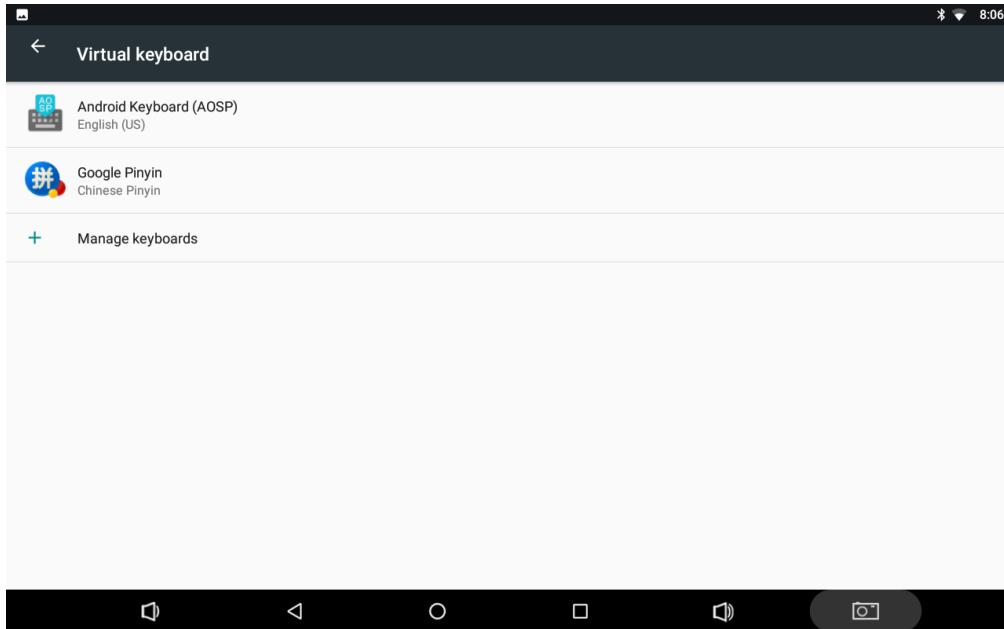

Take Photos

In the App list, tap  to launch the Camera app.

Tap  take a photo.



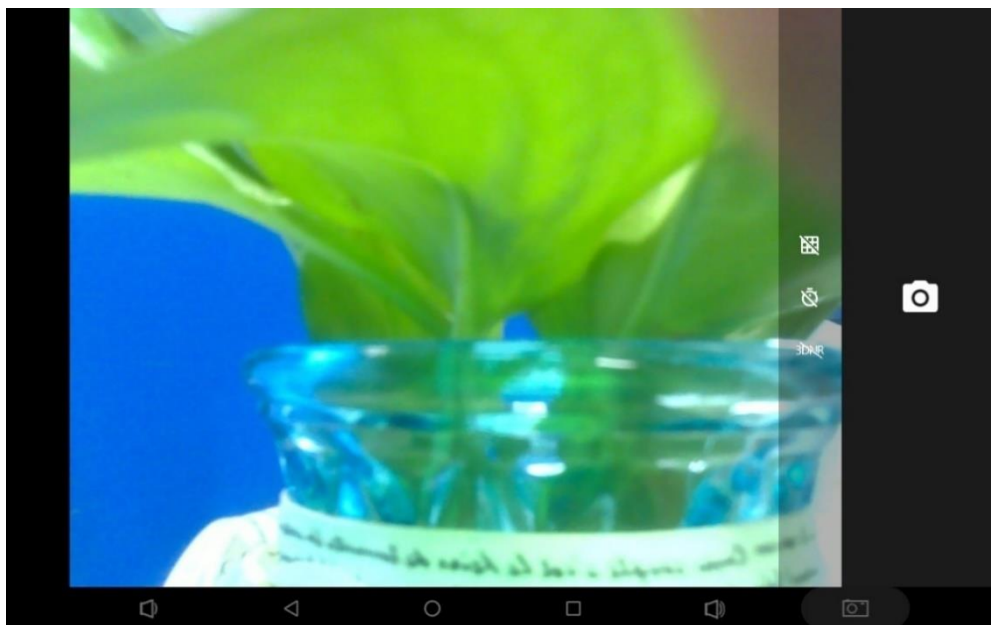

Tap  to open detail settings. From top to bottom in the picture are: grid lines, timer and 3DNR.



Surf Online

In the App list, tap  to launch the Browser app.

When connecting the device to a network, you can visit websites, play online media or download files via the browser.

In a browser window, enter a URL into the address bar and tap  on the virtual keyboard to open the URL. You can also tap  to add new tabs to open multiple webpages simultaneously in one window.

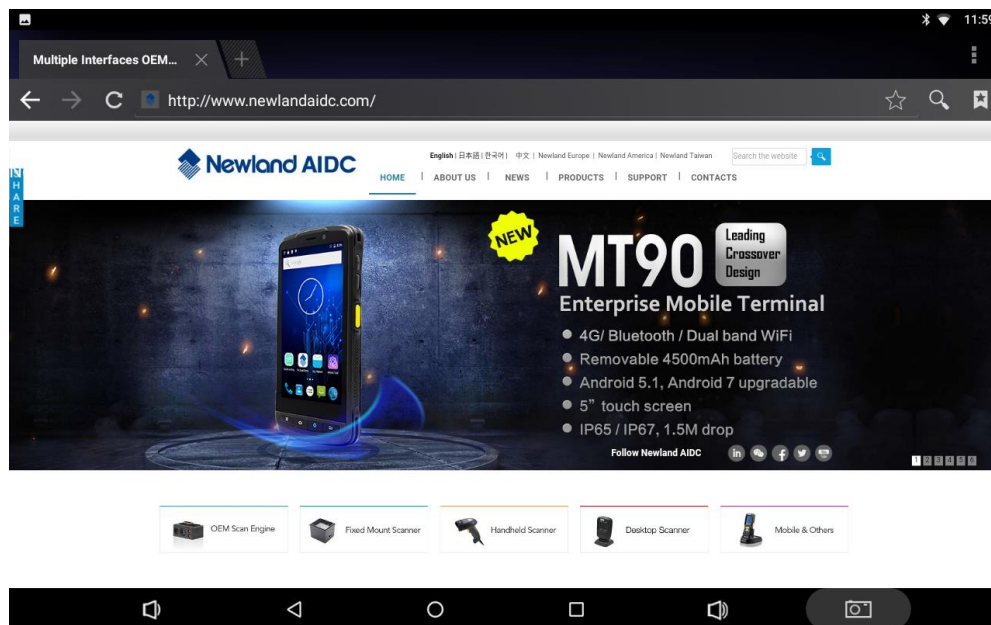

Browse Files

In the App list, tap “**Explorer**”  to view local files.

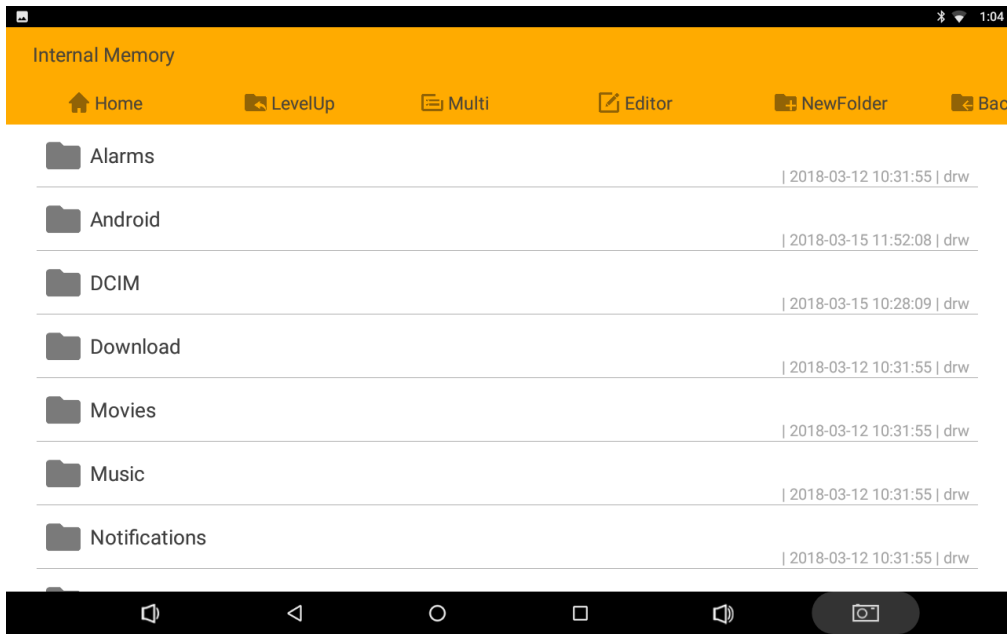

Long-tap a file or folder to perform file operations, such as copy, delete, move (cut), paste, rename, send (share) and create shortcut.

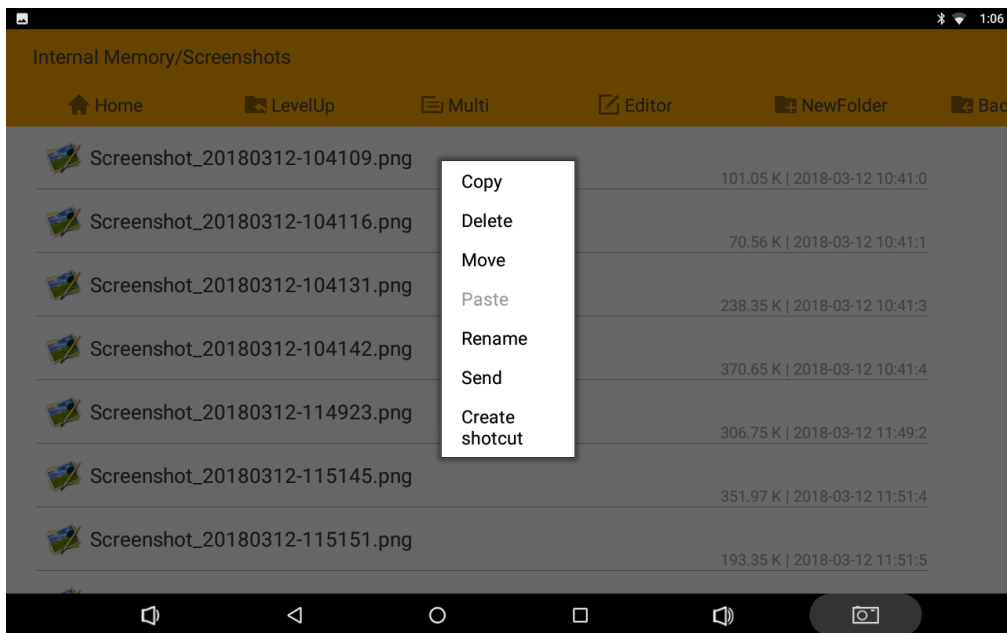

To select multiple files/folders, tap **“Multi”** in the menu and then select files/folders. The selected files/folders will be highlighted in yellow.

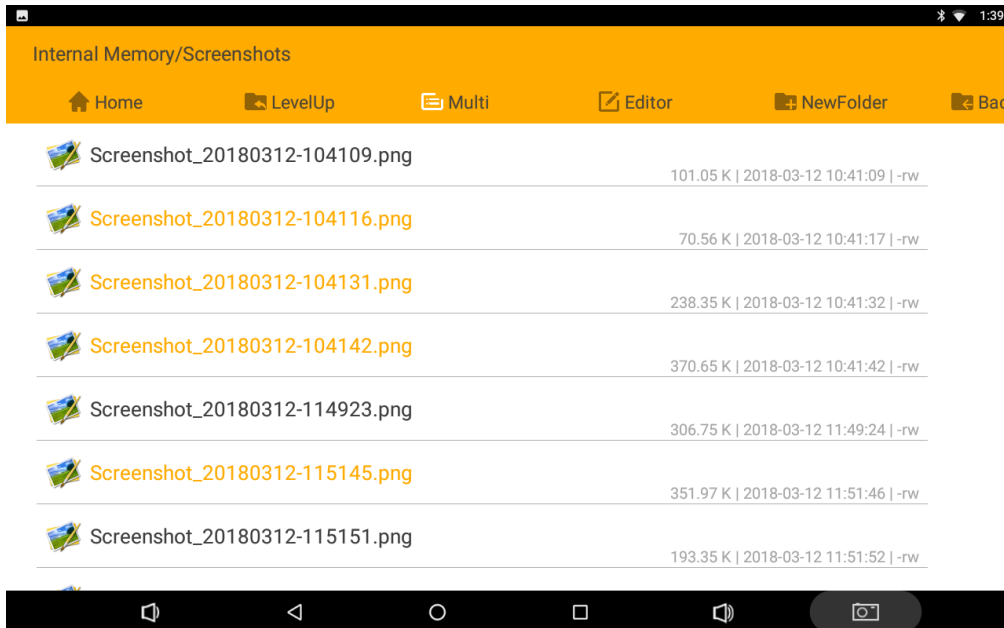

Tap **“Editor”** in the menu to operate the selected files/folders.

Play Media

With the provided apps, you can play your media files on your storage, such as pictures, music and videos.



Picture Player:

Support JPG, BMP, GIF, PNG.



Music Player:

Support MP2, WMA, WAV, AAC, OGG, ASF.



Video Player:

Support MKV, TS, FLV, AVI, VOB, MPG, DAT, ASF, RM, MOV, 3GP, MP4, WMV.

Install & Uninstall Apps

Install Apps

Before installing an app, please download the app (.apk) to using the browser, or copy a downloaded app (.apk) to the device from your computer.

Then you can open the ApkInstaller app  in the App list to install the downloaded app.

Tap **“Install”** button.

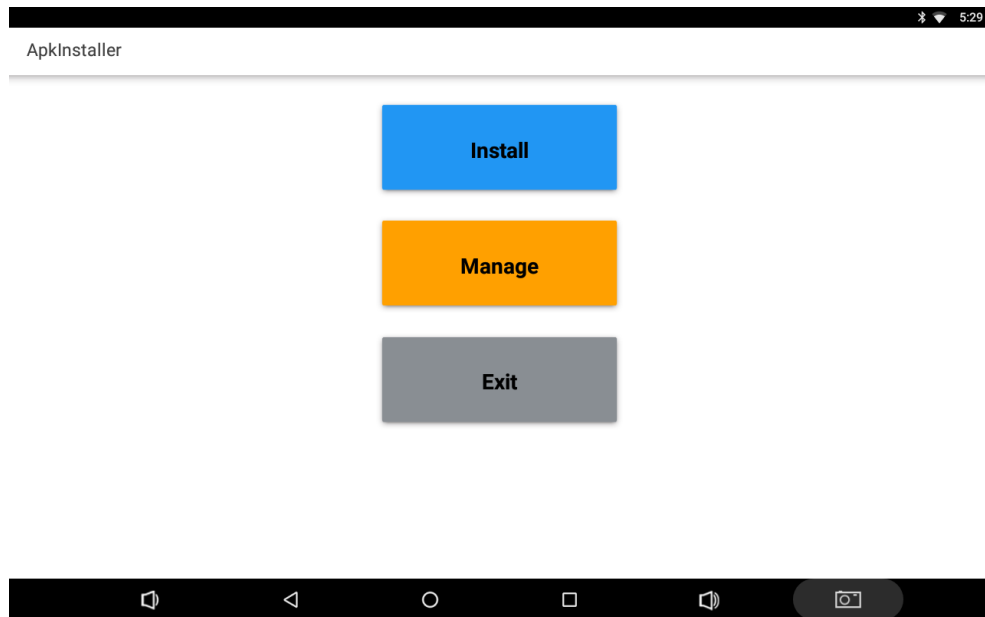

Open the folder containing the apk file.



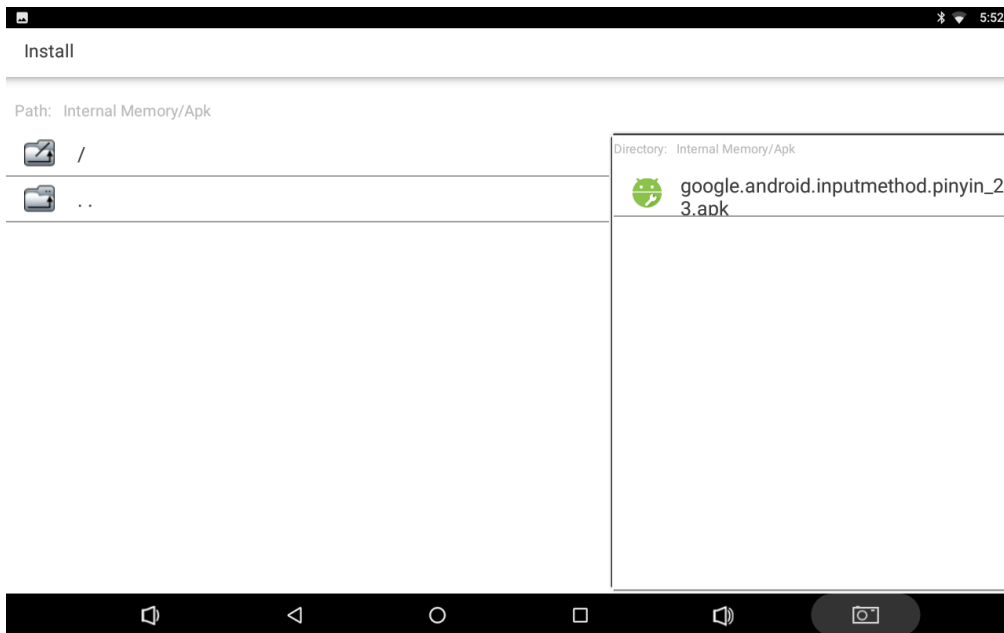

Tap the apk you want to install.

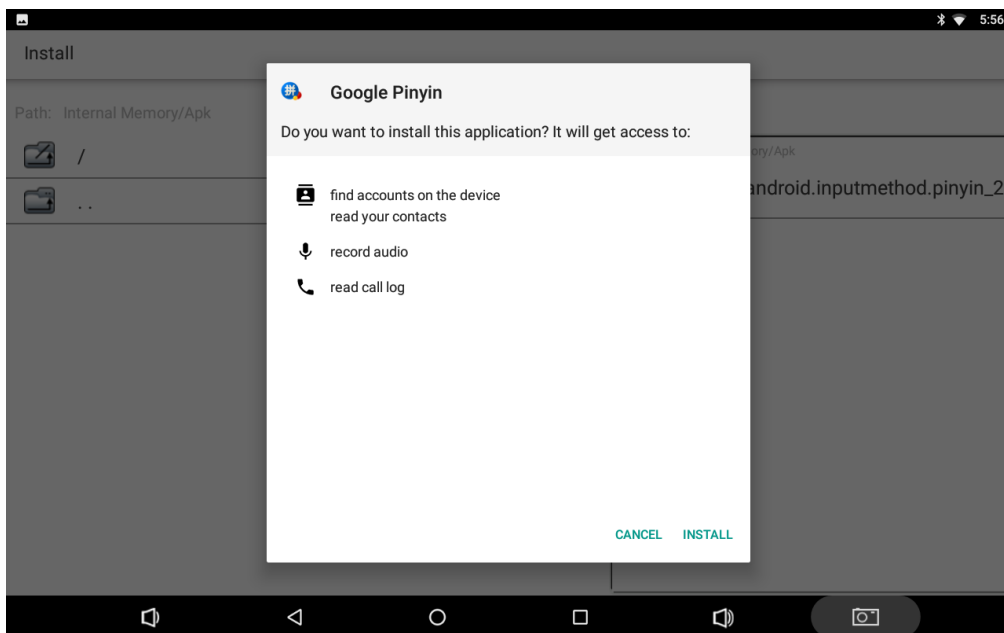

Tap **"INSTALL"** and then wait for the installation to complete.

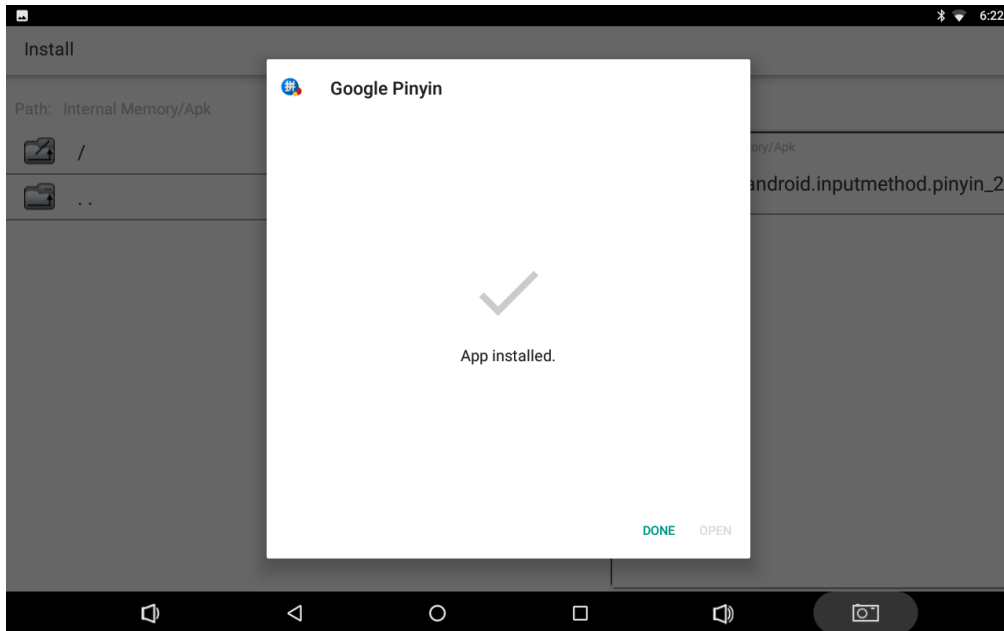

You can also download an android app market, and install the apps via the market.

If receiving the “For security, your tablet is set to block installation of apps obtained from unknown sources” message when installing an app, tap “**SETTINGS**”, and enable the “**Unknown sources**” option, and then reinstall the app.

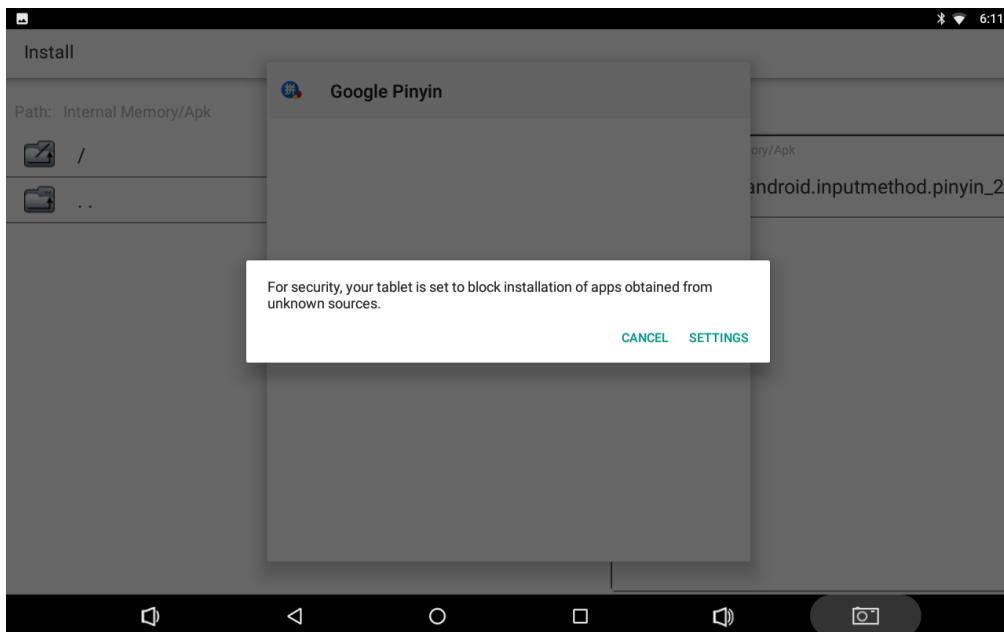

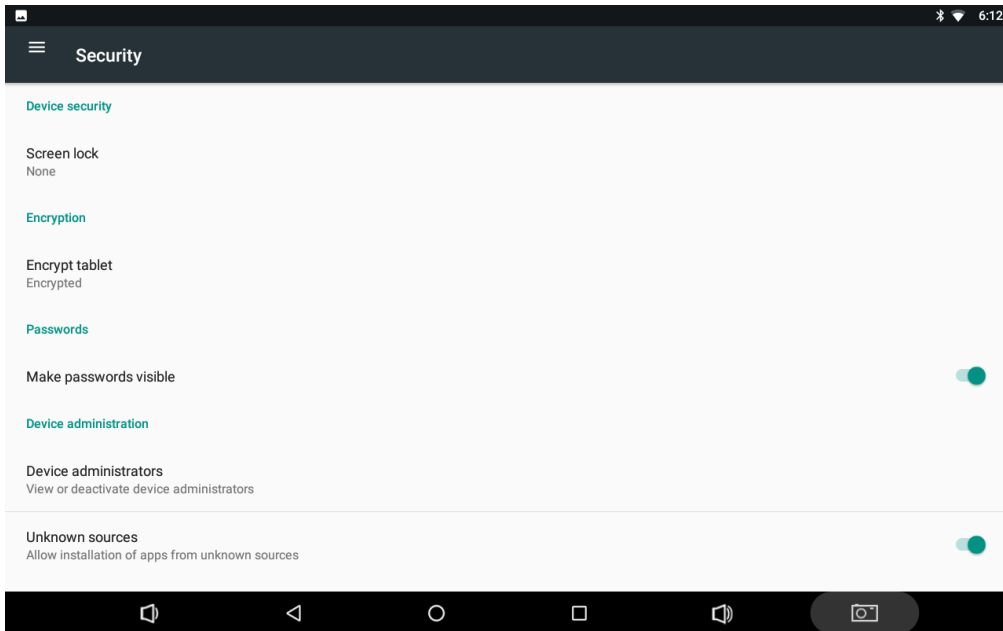

Uninstall Apps

To uninstall an app, Open the Settings app  in the App list, and select “**Apps**”.

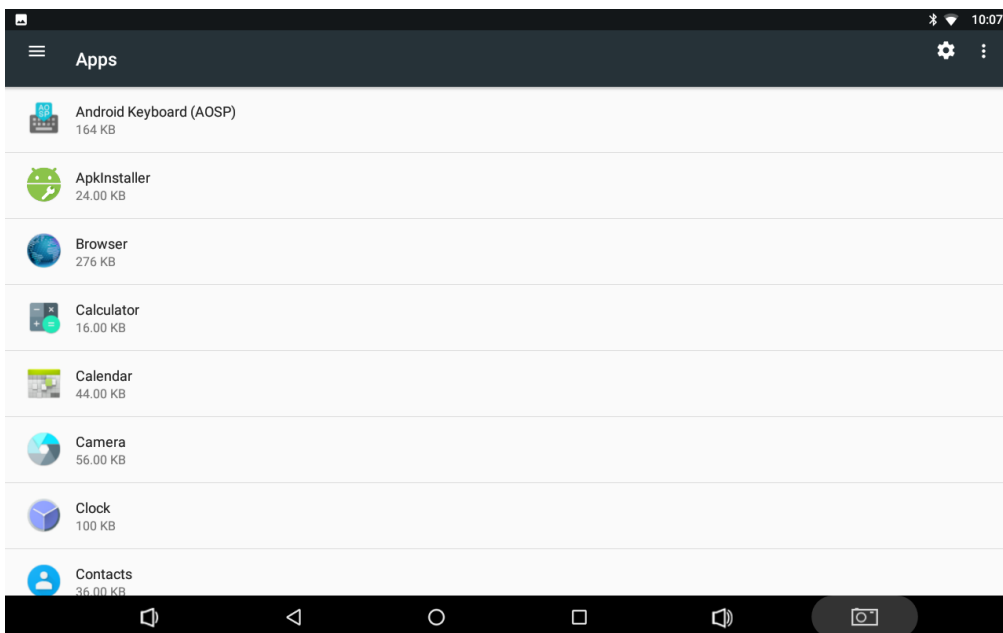

Tap the app you want to remove.

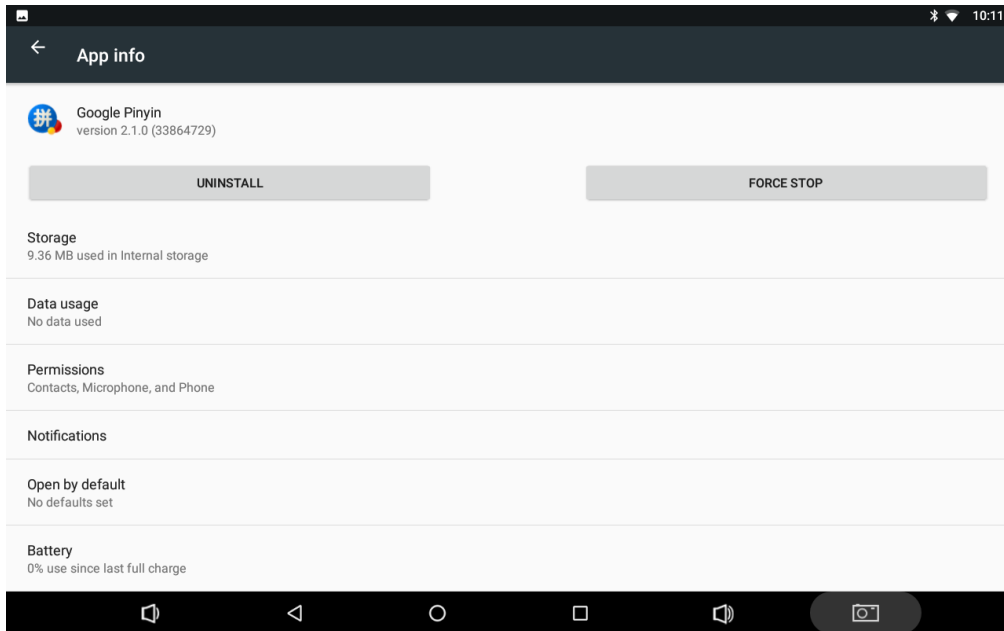

Tap the “UNINSTALL” button then “OK”, and then wait for the uninstallation to complete.

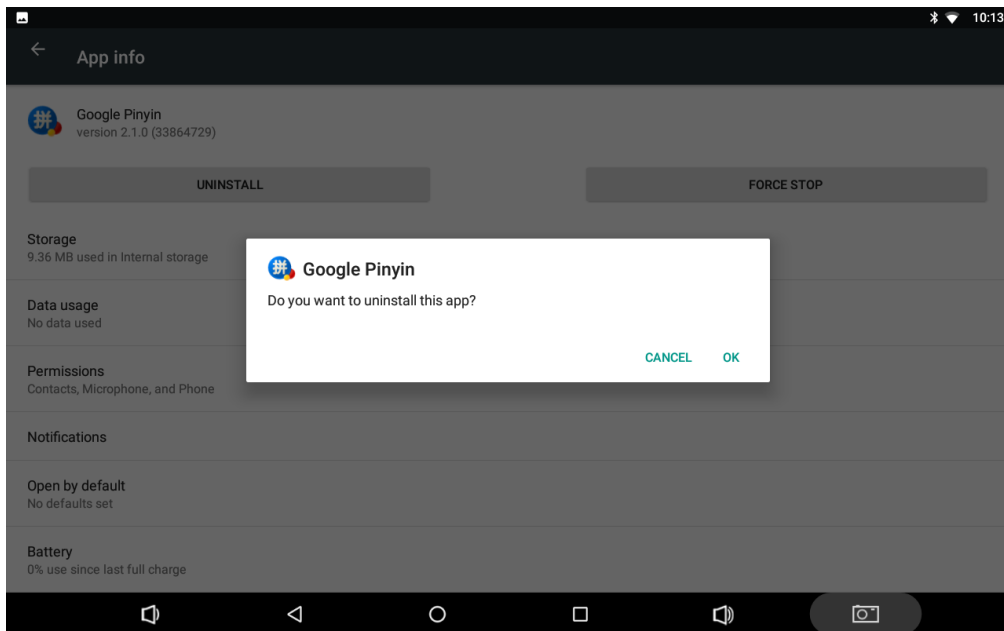

Reset to Factory Default

Please make sure to back up the important data before resetting the device.

In the App list, tap “**Settings**”  to open the system settings app, and select “**Backup & reset**”.

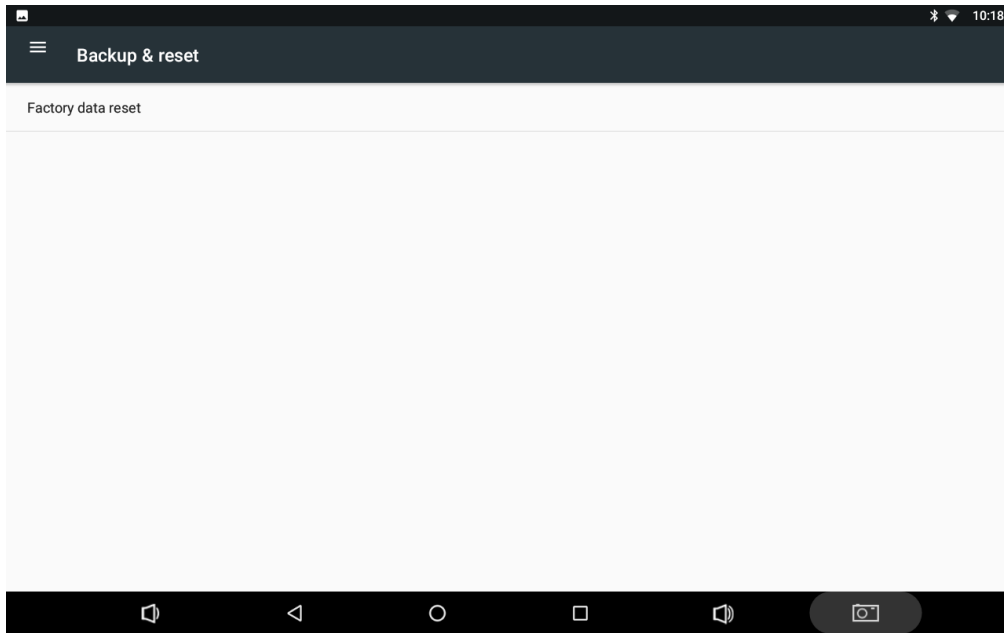

Tap “**Factory data reset**”.

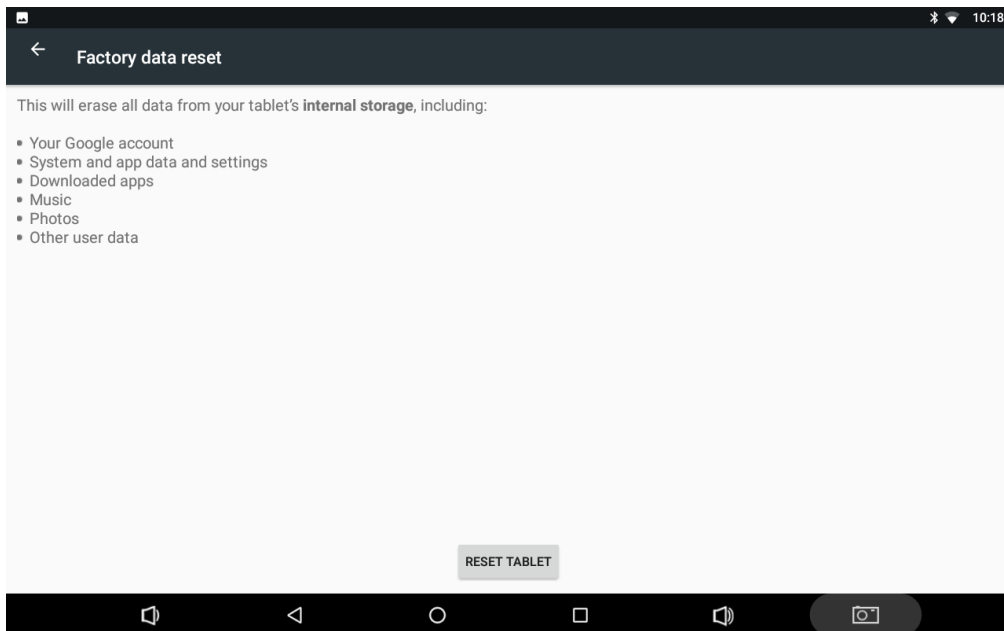

Tap the “**RESET TABLET**” button.

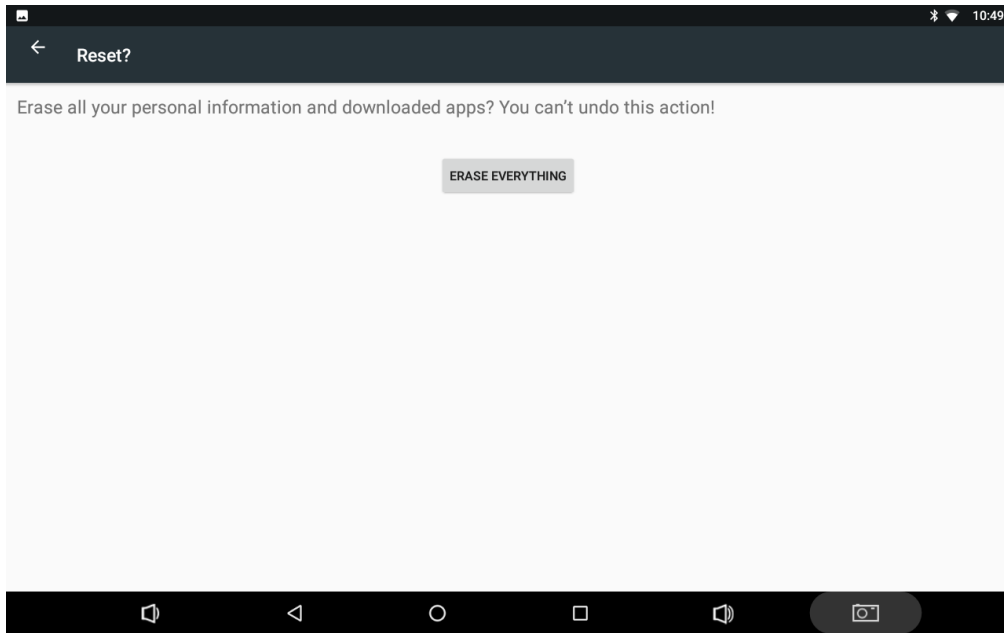

Tap the “**ERASE EVERYTHING**” button. Then the device will reboot and reset to factory default.



Newland

SCANNING MADE SIMPLE

Newland EMEA HQ
+31 (0) 345 87 00 33
info@newland-id.com
newland-id.com

Need more info? Contact us or one of
our partners at newland-id.com/partners