



Newland

SCANNING MADE SIMPLE



FM510 Series

IVD Scanners

User Guide

Version: 1.0.0

Disclaimer

© 2023 Newland Europe BV. All rights reserved.

Please read the manual carefully before using the product and operate it according to the manual. It is advised that you keep this manual for future reference.

Do not disassemble the device or remove the seal label from the device; doing so will void the product warranty provided by Newland Europe BV.

All pictures in this manual are for reference only, and the actual product may differ.

Regarding product modification and update, Newland Europe BV reserves the right to make changes to any software or hardware to improve reliability, function, or design at any time without notice. The information contained herein is subject to change without prior notice.

The products depicted in this manual may include software copyrighted by Newland Europe BV or a third party. The user, corporation or individual shall not duplicate, in whole or in part, distribute, modify, decompile, disassemble, decode, reverse engineer, rent, transfer, or sublicense such software without prior written consent from the copyright holders.

This manual is copyrighted. No part of this publication may be reproduced, distributed, or used in any form without Newland Europe BV's written permission.

Risk Warning Regarding Unauthorized System Updates:

You should use the Newland-provided tool to update this product's system. Modifying system files by installing a third-party ROM system or using any cracking method may result in product malfunction or data loss and void your warranty.

Newland Europe BV reserves the right to make a final interpretation of the statement above.

Newland Europe BV
Rolweg 25, 4104 AV, Culemborg, The Netherlands
www.newland-id.com

Newland Europe BV is a subsidiary of Newland Digital Technology Co., Ltd. Our general conditions of Purchase, Sale and Delivery are filed with the Record Office of the Chamber of Commerce of Utrecht, The Netherlands.

K.v.K. H.R. Utrecht / Chamber of Commerce Utrecht: Reg. nr. 17109876

Revision History

| Version | Description | Date |
|---------|------------------|---------------|
| V1.0.0 | Initial release. | July 12, 2022 |

Table of Contents

| | |
|---|-----------|
| Revision History | 3 |
| Preface | 1 |
| Introduction | 1 |
| Chapter Description | 1 |
| Explanation of Symbols..... | 2 |
| Explanation of Icons..... | 2 |
| Chapter 1 Getting Started | 3 |
| Introduction | 3 |
| Symbologies..... | 3 |
| FM510 Scanner..... | 4 |
| Chapter 2 Installation | 5 |
| Introduction | 5 |
| Dimensions (unit: mm) | 5 |
| Installation..... | 6 |
| Mounting | 8 |
| 7-pin Hot-tinned Wire | 9 |
| Length of Cable..... | 9 |
| ESD..... | 10 |
| Dust and Dirt | 10 |
| Ambient Environment..... | 10 |
| Thermal Considerations | 11 |
| Maintenance..... | 11 |
| Chapter 3 Optics..... | 12 |
| Introduction | 12 |
| Sensor..... | 12 |
| Illumination | 12 |
| LED Indicators..... | 13 |
| Window Size | 13 |
| Ambient Light | 14 |
| Eye Safety..... | 14 |
| Depth of Field..... | 15 |
| Chapter 4 Electrical Specifications..... | 16 |
| Power Supply..... | 16 |
| Ripple Noise..... | 16 |
| Interface Pinouts | 17 |
| DC Characteristics | 17 |

| | |
|--|-----------|
| Operating Voltage | 17 |
| Operating Current | 18 |
| I/O Voltage | 18 |
| Timing Sequence | 19 |
| Power Up Timing Sequence..... | 19 |
| Chapter 5 External Reference Circuit | 20 |
| External Circuit Design..... | 20 |
| Switching Output Circuit..... | 20 |
| Switching Input Circuit..... | 20 |
| Chapter 6 Easyset | 21 |
| EasySet..... | 21 |
| Chapter 7 Configuration | 22 |
| Introduction | 22 |
| Barcode Programming | 22 |
| Command Programming..... | 22 |
| EasySet Programming | 22 |
| Programming Barcode/ Programming Command/Function..... | 23 |
| Use of Programming Barcodes | 24 |
| Default Settings..... | 25 |
| Factory Defaults..... | 25 |
| Custom Defaults | 25 |
| Query Product Information | 26 |
| Query Product Name | 26 |
| Query Firmware Version | 26 |
| Query Decoder Version..... | 27 |
| Query Hardware Version..... | 27 |
| Query Product Serial Number | 27 |
| Query Manufacturing Date | 28 |
| Query OEM Serial Number | 28 |
| Query Data Formatter Version | 28 |
| Chapter 8 Communication Interface | 29 |
| Introduction | 29 |
| RS-232 Interface | 30 |
| Baud Rate | 31 |
| Parity Check..... | 32 |
| Data Bit | 33 |
| Stop Bit | 33 |
| Chapter 9 System Settings | 34 |

| | |
|---|-----------|
| Scan Mode | 34 |
| Decode Session Timeout | 34 |
| Reread Timeout..... | 36 |
| Good Read Delay..... | 38 |
| Bad Read Message..... | 39 |
| Set Bad Read Message | 40 |
| Trigger Commands..... | 40 |
| Modify Start Scanning Command | 41 |
| Modify Stop Scanning Command..... | 41 |
| Illumination | 43 |
| Good Read LED | 43 |
| Good Read LED Duration | 44 |
| Security Level..... | 45 |
| Switching Input Signal | 46 |
| Enable/Disable Switching Input..... | 46 |
| Trigger Slope..... | 47 |
| Trigger Duration | 47 |
| Debounce Duration | 48 |
| Switching Output Signal | 49 |
| Enable/Disable Switching Output..... | 49 |
| Output High/Low Level..... | 50 |
| Output Duration..... | 50 |
| Enable Level Output | 51 |
| Stop Level Output | 52 |
| Chapter 10 Symbologies..... | 53 |
| Introduction | 53 |
| Global Settings..... | 53 |
| Enable/Disable All Symbologies..... | 53 |
| Enable/Disable 1D Symbologies | 53 |
| Surround GS1 Application Identifiers (AI's) with Parentheses..... | 54 |
| Code 128..... | 55 |
| Restore Factory Defaults | 55 |
| Enable/Disable Code 128 | 55 |
| Set Length Range for Code 128 | 56 |
| EAN-8 | 57 |
| Restore Factory Defaults | 57 |
| Enable/Disable EAN-8 | 57 |
| Transmit Check Character | 57 |
| 2-Digit Add-On Code..... | 58 |
| 5-Digit Add-On Code..... | 59 |

| | |
|--|----|
| Add-On Code Required..... | 60 |
| Convert EAN-8 to EAN-13 | 60 |
| EAN-13 | 61 |
| Restore Factory Defaults | 61 |
| Enable/Disable EAN-13 | 61 |
| Transmit Check Character | 62 |
| 2-Digit Add-On Code..... | 62 |
| 5-Digit Add-On Code..... | 63 |
| Add-On Code Required..... | 63 |
| UPC-E..... | 64 |
| Restore Factory Defaults | 64 |
| Enable/Disable UPC-E..... | 64 |
| Transmit Check Character | 65 |
| 2-Digit Add-On Code..... | 65 |
| 5-Digit Add-On Code..... | 66 |
| Add-On Code Required..... | 66 |
| Transmit Preamble Character | 67 |
| Convert UPC-E to UPC-A | 67 |
| UPC-A..... | 68 |
| Restore Factory Defaults | 68 |
| Enable/Disable UPC-A..... | 68 |
| Transmit Check Character | 68 |
| 2-Digit Add-On Code..... | 69 |
| 5-Digit Add-On Code..... | 70 |
| Add-On Code Required..... | 71 |
| Transmit Preamble Character | 71 |
| Interleaved 2 of 5 | 72 |
| Restore Factory Defaults | 72 |
| Enable/Disable Interleaved 2 of 5 | 72 |
| Set Length Range for Interleaved 2 of 5 | 73 |
| Check Character Verification..... | 74 |
| Code 39 | 75 |
| Restore Factory Defaults | 75 |
| Enable/Disable Code 39 | 75 |
| Set Length Range for Code 39 | 76 |
| Check Character Verification..... | 77 |
| Transmit Start/Stop Character..... | 78 |
| Enable/Disable Code 39 Full ASCII | 78 |
| Enable/Disable Code 32 (Italian Pharma Code) | 79 |
| Code 32 Prefix | 79 |

| | |
|---|------------|
| Transmit Code 32 Start/Stop Character | 80 |
| Transmit Code 32 Check Character | 80 |
| Codabar | 81 |
| Restore Factory Defaults | 81 |
| Enable/Disable Codabar | 81 |
| Set Length Range for Codabar | 82 |
| Check Character Verification..... | 83 |
| Start/Stop Character | 84 |
| Code 93 | 85 |
| Restore Factory Defaults | 85 |
| Enable/Disable Code 93 | 85 |
| Set Length Range for Code 93 | 86 |
| GS1-128 (UCC/EAN-128) | 87 |
| Restore Factory Defaults | 87 |
| Enable/Disable GS1-128..... | 87 |
| Set Length Range for GS1-128..... | 88 |
| Chapter 11 Data Formatter..... | 89 |
| Introduction | 89 |
| Add a Data Format..... | 89 |
| Programming with Barcodes | 89 |
| Programming with Serial Commands..... | 92 |
| Enable/Disable Data Formatter | 93 |
| Data Format Selection | 94 |
| Change Data Format for a Single Scan | 96 |
| Clear Data Format..... | 97 |
| Query Data Formats..... | 97 |
| Formatter Command Type 6 | 98 |
| Send Commands | 98 |
| Move Commands..... | 101 |
| Search Commands | 103 |
| Miscellaneous Commands | 106 |
| Chapter 12 Prefix & Suffix | 112 |
| Introduction | 112 |
| Global Settings..... | 113 |
| Enable/Disable All Prefixes/Suffixes..... | 113 |
| Prefix Sequence..... | 113 |
| Custom Prefix..... | 114 |
| Enable/Disable Custom Prefix | 114 |
| Set Custom Prefix | 114 |

| | |
|--|------------|
| AIM ID Prefix..... | 115 |
| Code ID Prefix..... | 116 |
| Restore All Default Code IDs | 116 |
| Modify Code ID | 117 |
| Custom Suffix..... | 120 |
| Enable/Disable Custom Suffix..... | 120 |
| Set Custom Suffix | 120 |
| Data Packing..... | 121 |
| Introduction | 121 |
| Data Packing Options | 121 |
| Terminating Character Suffix..... | 123 |
| Enable/Disable Terminating Character Suffix..... | 123 |
| Set Terminating Character Suffix..... | 123 |
| Chapter 13 Programming Commands | 125 |
| Use of Programming Command..... | 125 |
| Query Commands..... | 125 |
| Command Syntax | 125 |
| Responses | 126 |
| Examples | 126 |
| Read Barcode On/Off..... | 128 |
| Turn On Good Read LED..... | 128 |
| Turn On Illumination LED..... | 128 |
| Chapter 14 Batch Programming..... | 129 |
| Introduction | 129 |
| Create a Batch Command..... | 130 |
| Create a Batch Barcode..... | 130 |
| Use Batch Barcode | 131 |
| Appendix | 132 |
| Digit Barcodes..... | 132 |
| Save/Cancel Barcodes..... | 135 |
| Factory Defaults Table (MONGO-P_V2.ST.G02.2) | 136 |
| AIM ID Table (V2022.6)..... | 140 |
| Code ID Table (V1.00.0)..... | 141 |
| Symbology ID Number (V1.00.0) | 142 |
| ASCII Table | 143 |
| Unicode Key Maps | 147 |

Preface

Introduction

This manual provides installation, optics, electrical specifications as well as detailed instructions for setting up and using the NLS-FM510 series fixed mount barcode scanner (hereinafter referred to as “the FM510” or “the scanner”).

This guide provides programming instructions for the FM510. Users can configure the FM510 by scanning the programming barcodes included in this manual.

The FM510 has been properly configured for most applications and can be put into use without further configuration. Users may check Appendix: Factory Defaults Table for reference.

Chapter Description

- ❖ *Chapter 1, Getting Started* : Gives a general description of the FM510.
- ❖ *Chapter 2, Installation* : Describes how to install the scanner, including installation information, connector, cable, ESD, and environmental considerations.
- ❖ *Chapter 3, Optics* : Provides parameters for optics and illumination.
- ❖ *Chapter 4 Electrical Specifications* : Includes the electrical characteristics for the scanner and timing sequences.
- ❖ *Chapter 5 External Reference Circuit* : Provide external driver circuit diagrams.
- ❖ *Chapter 6, EasySet* : Introduces a useful tool you can use to set up the FM510.
- ❖ *Chapter 7 Configuration* : Introduces the use of programming barcodes and product information query.
- ❖ *Chapter 8 Communication Interface* : Describes how to configure RS-232 communication parameters.
- ❖ *Chapter 9, System Settings* : Describes how to configure general parameters of the FM510.
- ❖ *Chapter 10, Symbologies* : Lists all compatible symbologies and describes how to configure the relevant parameters.
- ❖ *Chapter 11, Data Formatter* : Explains how to customize scanned data with the advanced data formatter.
- ❖ *Chapter 12, Prefix & Suffix* : Describes how to use prefix and suffix to customize scanned data.
- ❖ *Chapter 13 Programming Commands* : Introduces how to configure the FM510 by serial commands sent from the





host.

- ◇ *Chapter 14, Batch Programming* : Explains how to integrate a complex programming task into a single barcode.
- ◇ *Appendix* : Provides factory defaults table and a bunch of frequently used programming barcodes.

Explanation of Symbols

- This symbol indicates lists of required steps.
- ※ This symbol indicates notes of some parameters.

Explanation of Icons

| | |
|---|--|
|  | This icon indicates auxiliary tools that help users to refer to the manual at ease. |
|  | This icon indicates this information requires extra attention from the reader. |
|  | This icon indicates handy tips that can help you use or configure the scanner with ease. |
|  | This icon indicates practical examples that can help you to acquaint yourself with operations. |

Chapter 1 Getting Started

Introduction

The NLS-FM510 series products are 1D linear barcode scanners for medical applications, mainly integrated into testing instruments in laboratories, hospitals and assembly lines. It delivers fast and reliable reading of 1D printed barcodes on short-distance test tubes or reagent bottles. The NLS-FM510 series includes NLS-FM510-V (lateral beam exit) and NLS-FM510-H (front beam exit), distinguished by the direction of the beam exit.



Note: This guide provides general instructions for the installation. Fujian Newland Auto-ID Tech. Co., Ltd. recommends an opto-mechanical engineer should conduct an opto-mechanical analysis before design.

Symbologies

The FM510 can easily read printed barcodes and on-screen barcodes, including:

| | |
|----|---|
| 1D | Code 128, EAN-8, EAN-13, EAN-13 Addendum, UPC-E, UPC-A, Interleaved 2/5, Code 39, Codabar, Code 93, UCC/EAN-128 |
|----|---|

FM510 Scanner

FM510-H

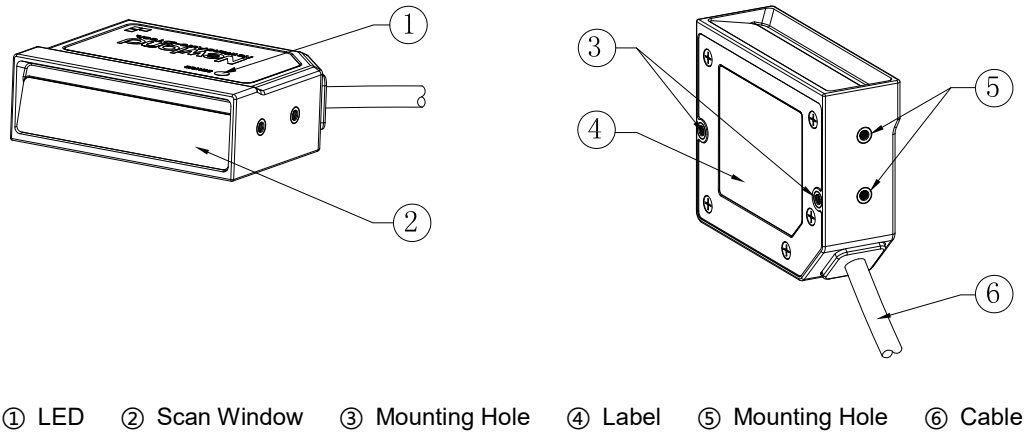

Figure 1-1

FM510-V

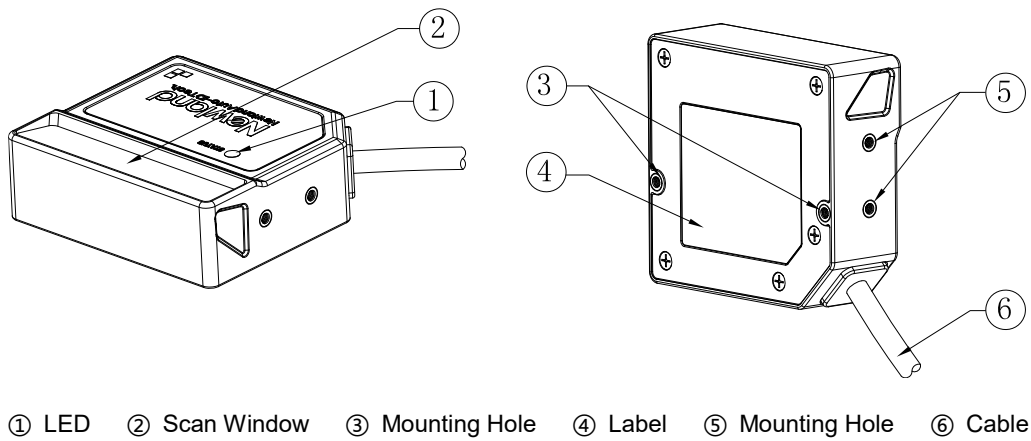

Figure 1-2

Chapter 2 Installation

Introduction

This chapter explains how to install the FM510, including general requirements, housing design, and physical and optical information.



Caution: Do not touch the imaging lens when installing the scanner. Be careful not to leave fingerprints on the lens.



Caution: Do not touch the illumination LED during handling. Improper handling may damage the LED.

Dimensions (unit: mm)

FM510-H: 62.5(W)×50.5(D)×21.5(H) (max.)

FM510-V: 62.5(W)×57(D)×21.5(H) (max.)

Installation

FM510-H

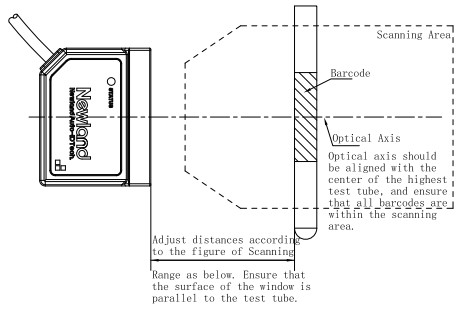

Side View

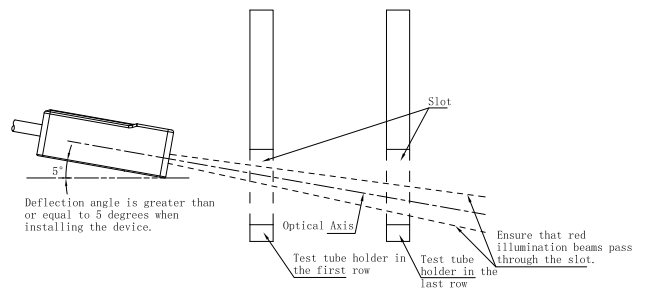

Top View

NLS-FM510-H Scanning Range

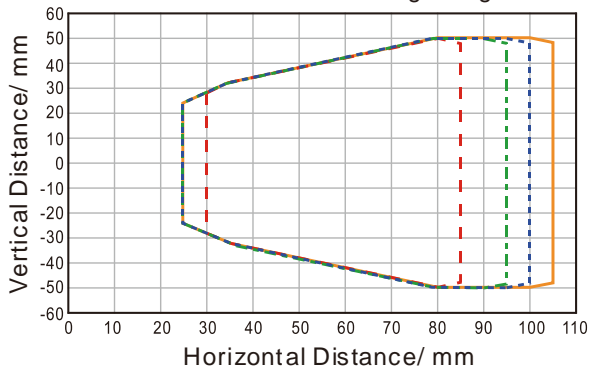

**Code 128
Grade A**

- - - 6.67mil
- - - 8.34mil
- - - 10mil
- 13.34mil-20mil

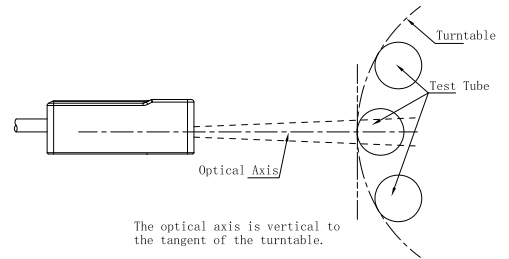
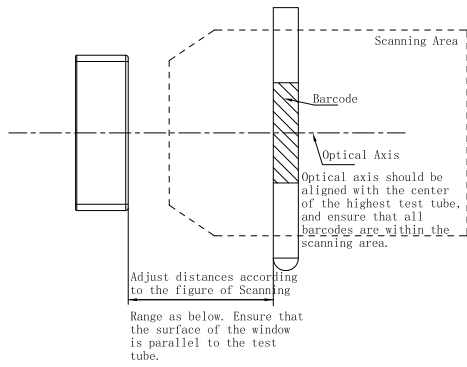
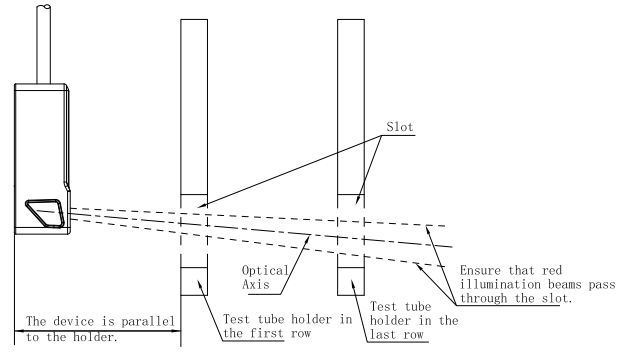

Figure 2-1

FM510-V



Side View



Top View

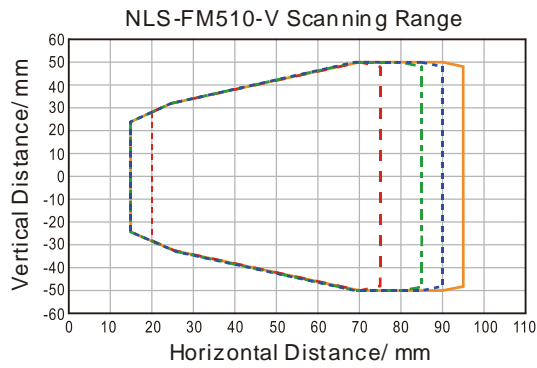

- Code 128
Grade A**
- - - 6.67mil
 - - - 8.34mil
 - - - 10mil
 - 13.34mil-20mil

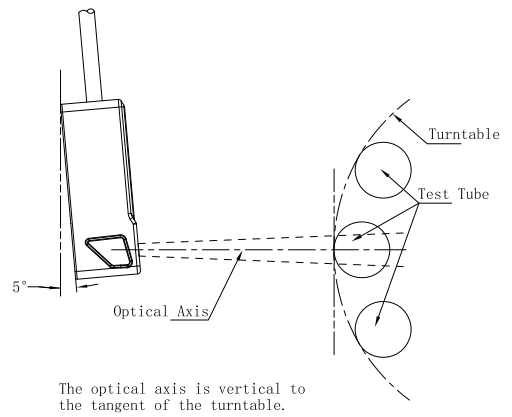

Figure 2-2

Mounting

The illustrations below show the mechanical mounting dimensions (unit: mm) for the FM510.

FM510-H

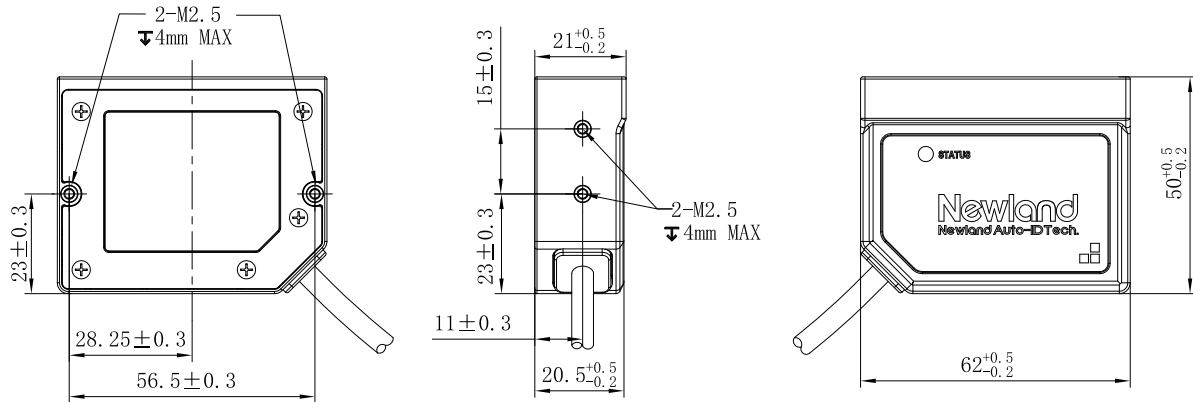

Figure 2-3

FM510-V

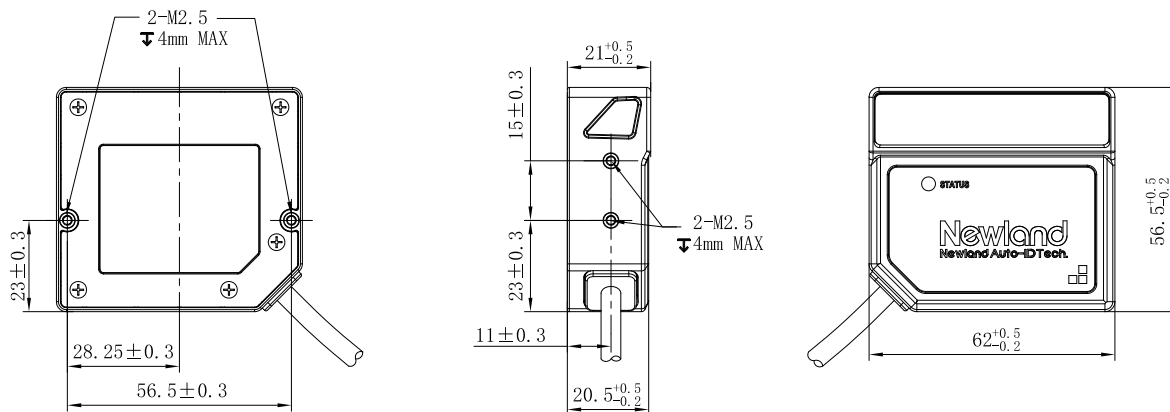

Figure 2-4

7-pin Hot-tinned Wire

The FM510 with 7-pin hot-tinned wire can be connected to the host:

- 7-pin hot-tinned wire can be used as RS-232 communication.

The figure below illustrates wire colors of the 7-pin hot-tinned wire.

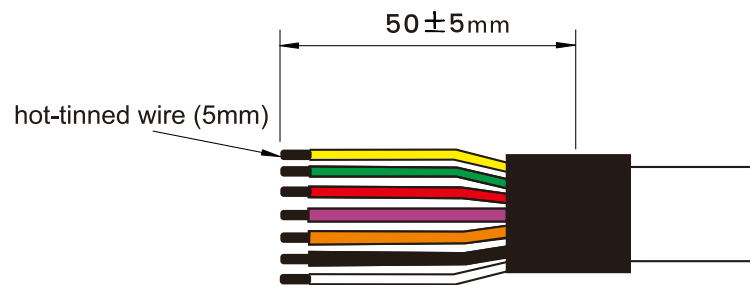

Figure 2-5

Length of Cable

FM510-H

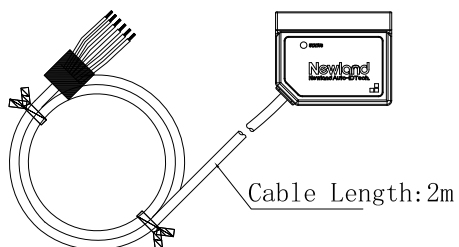

Figure 2-6

FM510-V

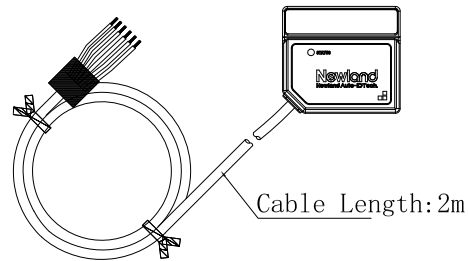

Figure 2-7

ESD

ESD protection has been taken into account when designing the FM510. However, due to limited board space, additional ESD protection, such as TVS protection, is not provided on the scanner's I/O interface. It is advised to take corresponding protection measures when integrating the scanner.

The scanner is shipped in ESD safe packaging. Always exercise care when handling the scanner outside its package. Be sure grounding wrist straps and properly grounded work areas are used.

Dust and Dirt

The FM510 must be sufficiently enclosed to prevent dust particles from gathering on the lens and circuit board. Dust and other external contaminants will eventually degrade the scanner's performance.

Ambient Environment

The following environmental requirements should be met to ensure good performance of the FM510.

Table 2-1

| | |
|-----------------------|-------------------------|
| Operating Temperature | 0°C to 50°C |
| Storage Temperature | -40°C to 70°C |
| Humidity | 5%~95% (non-condensing) |

Thermal Considerations

Electronic components in the FM510 will generate heat during the course of their operation. Operating the FM510 in continuous mode for an extended period may cause temperatures to rise on CPU, CIS, LEDs, DC-DC, etc. Overheating can degrade image quality and affect scanning performance. Given that, the following precautions should be taken into consideration when integrating the FM510.

- ✧ Reserve sufficient space for good air circulation in the design.
- ✧ Avoid wrapping the FM510 with thermal insulation materials such as rubber.

Maintenance

- ✧ The scan window should be kept clean.
- ✧ Do not scratch the scan window.
- ✧ Use the soft cloth to clean the window, such as eyeglass cleaning cloth.
- ✧ Do not spray any liquid on the scan window.
- ✧ Do not use any detergent to clean other parts of the device except for water.
- ✧ Please remove the protective film before using the device.

Note: The warranty DOES NOT cover damages caused by inappropriate care and maintenance.

Chapter 3 Optics

Introduction

The FM510 contains:

- a CCD image sensor and its lens
- two LEDs based illumination system and two lenses

Sensor

Pixel: 2500*1 CCD

Frame rate: 780fps

Illumination

The FM510 has two red LEDs for supplementary lighting, making it possible to scan barcodes even in complete darkness. The illumination can be programmed On or Off. Customers can add the external illumination system if needed. The spectral range should be within the visible light.

The illumination LEDs produce a bar-shaped pattern to help the user to easily position the target barcode within the scanner's field of view to increase scan efficiency.

Note: when the scanner comes closer to the barcodes, illumination center and imaging center may deviate.



Bar-shaped Pattern Illumination

Figure 3-1

LED Indicators

Table 3-1

| LED Indicators | Description |
|-------------------------|--|
| Blue LED on | The device is powered on and enters the standby state. |
| Green LED flashes 200ms | It indicates a good read. |
| Red LED flashes 200ms | It indicates device malfunction. |

Window Size

The window must not block the field of view and should be sized to accommodate FOV envelopes shown below.

FM510-H

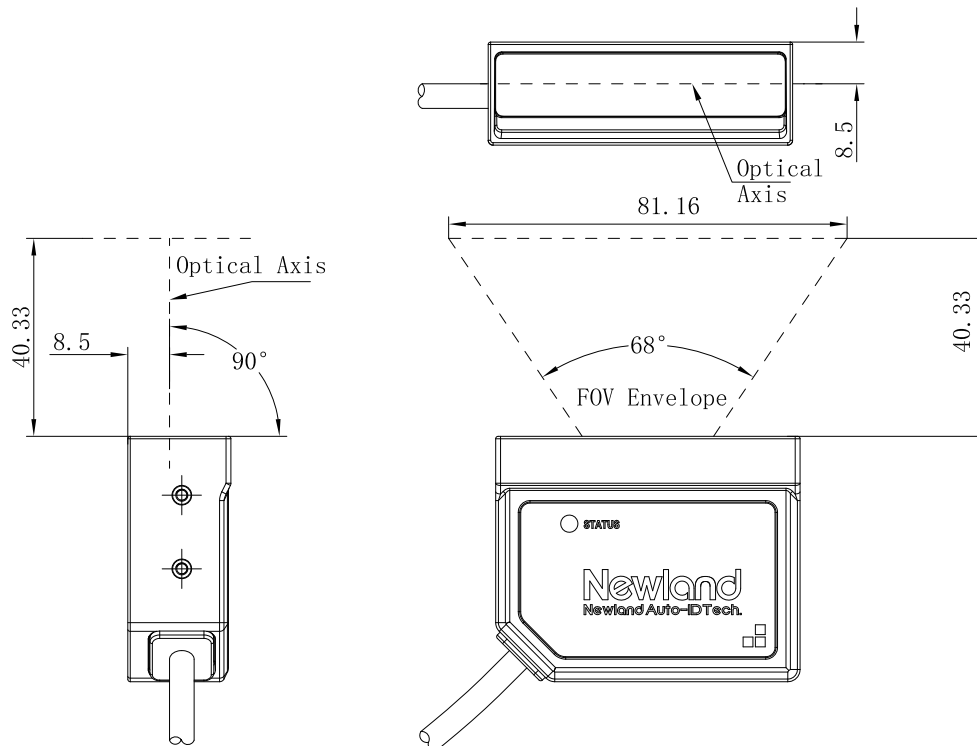

Figure 3-2

FM510-V

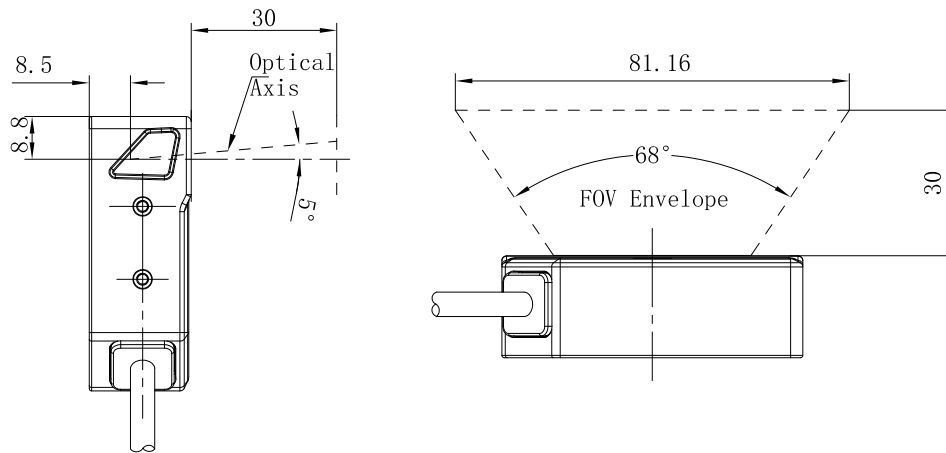

Figure 3-3

Ambient Light

The FM510 shows better performance with ambient light. However, high-frequency pulsed light can result in performance degradation.

Eye Safety

The FM510 has no lasers. It uses LEDs to produce illumination beam. The LEDs are bright, but testing has been done to demonstrate that the scanner is safe for its intended application under normal usage conditions. However, the user should avoid looking into the beam.

LED Compliance Statement

The FM510 complies with IEC 62471:2006 for LED safety.

Depth of Field

The tables below list the depth of view tested in the 0lx and 300lx natural light.

Table 3-2

Ambient light: 0lux or 300lux natural light

| | |
|---------|----------|
| FM510-H | 25~105mm |
| FM510-V | 15~95mm |

Chapter 4 Electrical Specifications

Power Supply

Do not power up the FM510 until it is properly connected. Be sure the power is cut off before connecting a cable to or disconnecting a cable from the host interface connector. Hot-plugging could damage the scanner.

Unstable power supply or sharp voltage drops or unreasonably short interval between power-ons may lead to unstable performance of the scanner. Do not resupply the power immediately after cutting it off.



1. When designing, the user should ensure that the input power of FM510 is fully decoupled. It is recommended to place a 22uF and a 100nF X5R or X7R ceramic capacitor beside the power input pin on the connector which is soldered on the board.
2. Ensure that the input power drops below 0.5V before powering the FM510 on again, otherwise it will lead to abnormal function.

Ripple Noise

To ensure the image quality, a power supply with low ripple noise is needed.

Acceptable ripple range (peak-to-peak) $\leq VCC * 5\%$

Interface Pinouts

The following table lists the pin functions of the 7-pin hot-tinned wire connector.

Table 4-1

| PIN# | Signal | I/O | State | Function | Remark |
|--------|-----------|-----|-----------|---------------------|------------|
| Red | DC IN | / | / | Power input | |
| Orange | SW IN | I | Low level | Switching input | See Note 1 |
| Purple | GND | / | / | Power-supply ground | |
| Black | SW OUT | O | Low level | Switching output | See Note 2 |
| White | RS232 RXD | I | Low level | RS-232 input | |
| Green | RS232 TXD | O | / | RS-232 output | |
| Yellow | Shield | / | / | Shield | |

※ I = Input; O = Output; od = Open Drain;

※ 1 The SW IN pin is used as trigger signal. A trigger pull (default duration: 10ms) activates a decode session. The decode session continues until a barcode is decoded or you release the trigger.

For the external switching input circuit, please see the “Switching Input Circuit” section in Chapter 5.

For more details, please see the “Switching Input Signal” section in Chapter 9.

※ 2 The SW OUT pin is reserved as external switching output signal. If this pin is not used, leave it unconnected. It produces high level (duration: 400ms) after a barcode is decoded.

For the external switching output circuit, please see the “Switching Output Circuit” section in Chapter 5.

For more details, please see the “Switching Output Signal” section in Chapter 9.

DC Characteristics

Operating Voltage

Table 4-2

T=25°C

| Parameter | Description | Minimum | Typical | Maximum | Unit |
|-----------|---------------|---------|---------|---------|------|
| VCC | Input Voltage | 4.75 | 5 | 24 | V |

Operating Current

Table 4-3

T=25°C

| Mode | | State | Typical | Maximum | Unit |
|-----------------|-------------------|--------|---------|---------|------|
| Working Current | RMS ¹ | VCC=5V | 275 | 370 | mA |
| | PEAK ² | | / | 850 | mA |
| Idle Current | RMS ¹ | | 150 | 180 | mA |

1. RMS indicates the RMS value of the current under the stable working state.

2. PEAK indicates the peak current the device reaches.

I/O Voltage

Table 4-4

GND =0 V, T=25°C

| Parameter | Description | Condition | Minimum | Typical | Maximum | Unit |
|-----------|-------------|-----------|---------|---------|---------|------|
| SW_IN | VIL | T=25°C | 0 | / | 0.8 | V |
| | VIH | T=25°C | 4.0 | / | 5.0 | V |
| SW_OUT | VOL | T=25°C | 0 | / | 0.4 | V |
| | VOH | T=25°C | / | / | 24 | V |

Note: The VOH of SW_OUT determined by the pull-up voltage should not exceed 24V.

Timing Sequence

Power Up Timing Sequence

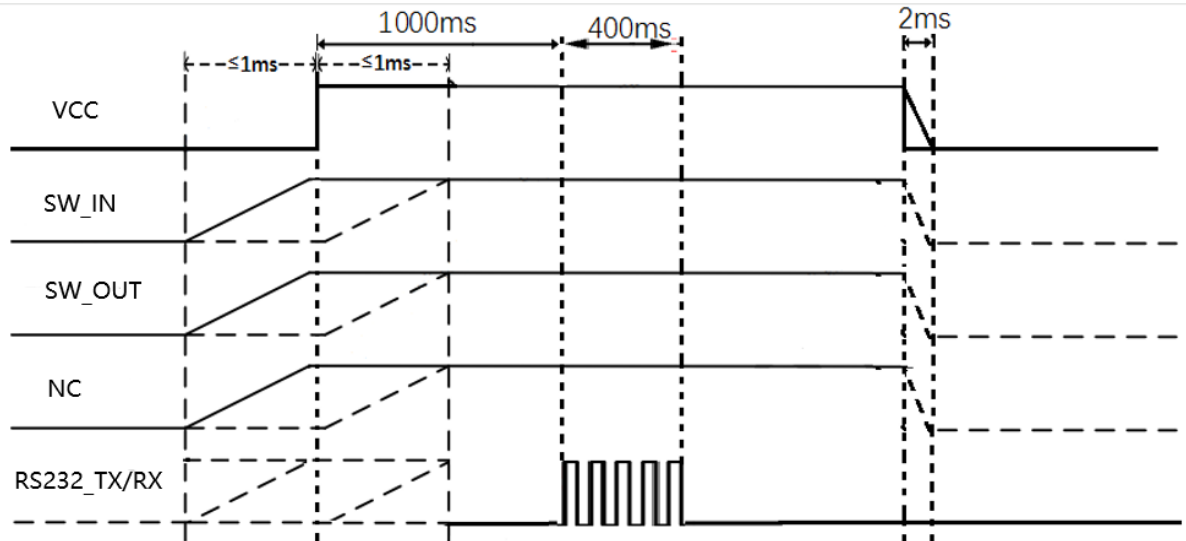

Figure 4-1

1. Before powering on the scanner, ensure that all the signals remain low to prevent current from flowing backwards to affect the performance of the scanner. Initialization will be completed within 1s if the scanner functions well after power-on.
2. The initialization completes and the scanner can receive serial commands from the host.
3. Before powering off the scanner, all the signals should drive low within 2ms. To ensure that the scanner works at a stable level, the minimum interval between removing and resupplying the power must exceed 2s.



@SETUPE1
Enter Setup

Chapter 5 External Reference Circuit

External Circuit Design

Switching Output Circuit

The circuit below is used to drive an external switch output signal. This pin is reserved as external output interface. The SW_OUT signal is from black wire of the 7-pin hot-tinned wire.

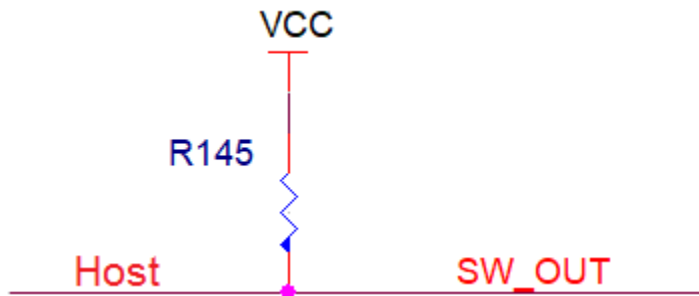

Figure 5-1

Switching Input Circuit

The circuit below is used to provide the scanner with a signal to trigger a scan and decode session. The SW_IN signal is from orange wire of the 7-pin hot-tinned wire.

Keep the signal high to trigger a decode session (default: low level).

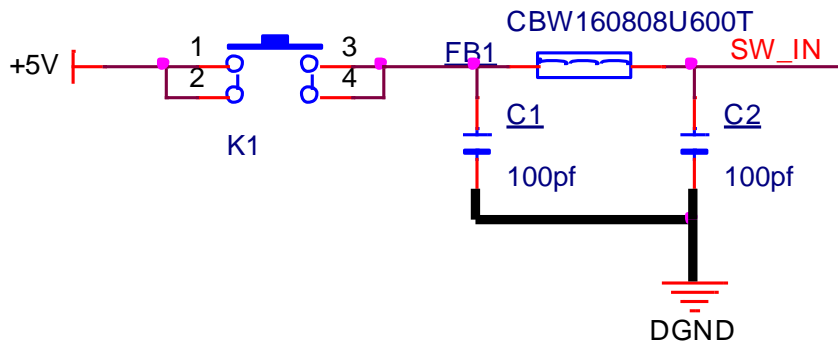

Figure 5-2



@SETUPE0
** Exit Setup



@SETUPE1
Enter Setup

Chapter 6 Easyset

EasySet

EasySet, developed by Fujian Newland Auto-ID Tech. Co., Ltd., is a configuration tool for Newland's 1D/2D handheld barcode scanner, fixed mount barcode scanners and OEM scan engines. Its main features include:

- ✧ View device & configuration information of online device
- ✧ Configure device
- ✧ Update firmware of online device
- ✧ Load/modify existing XML configuration file; save current settings to an XML file
- ✧ Create/print/save programming barcodes to a PDF or Word file
- ✧ View/edit/save image stored on online device in the original image/BMP/JPG/TIFF format
- ✧ Send serial commands to online device and receive device response
- ✧ Supported languages: Chinese and English

EasySet supports 32-bit/64-bit Microsoft WinXP/Win7/Win 8/Win 8.1/Win 10 operating systems.

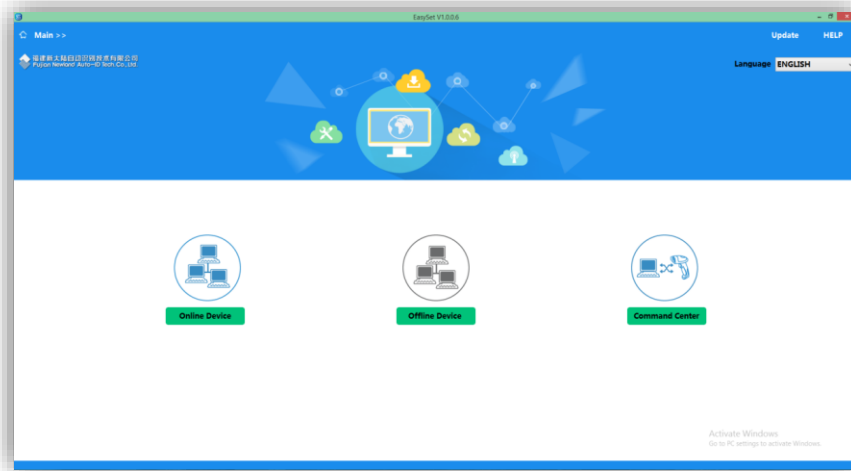

@SETUPE0
** Exit Setup



@SETUPE1
Enter Setup

Chapter 7 Configuration

Introduction

There are three ways to configure the FM510: Barcode programming, command programming and Easyset programming.

Barcode Programming

The FM510 can be configured by scanning programming barcodes. All user programmable features/options are described along with their programming barcodes/commands in the following sections.

This programming method is most straightforward. However, it requires manually scanning barcodes. As a result, errors are more likely to occur.

Command Programming

The FM510 can also be configured by serial commands sent from the host device.

Users can design an application program to send those command strings to the scanners to perform device configuration.

EasySet Programming

Besides the two methods mentioned above, you can conveniently perform scanner configuration through EasySet too. EasySet is a Windows-based configuration tool particularly designed for Newland products, enabling users to gain access to decoded data and captured images and to configure scanners. For more information about this tool, refer to the *EasySet User Guide*.



@SETUPE0
** Exit Setup



@SETUPE1
Enter Setup

Programming Barcode/ Programming Command/Function



The figure above is an example that shows you the programming barcode and command for the Enter Setup function:

1. The **No Case Conversion** barcode.
2. The **No Case Conversion** command.
3. The description of feature/option.



@SETUPE0
** Exit Setup



@SETUPE1
Enter Setup

Use of Programming Barcodes

Scanning the **Enter Setup** barcode can enable the scanner to enter the setup mode. Then you can scan a number of programming barcodes to configure your scanner. To exit the setup mode, scan the **Exit Setup** barcode or a non-programming barcode, or reboot the scanner.



@SETUPE0
Exit Setup

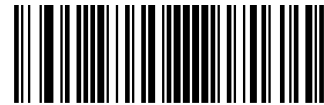

@SETUPE1
Enter Setup

Programming barcode data (i.e. the characters under programming barcode) can be transmitted to the host device. Scan the appropriate barcode below to enable or disable the transmission of programming barcode data to the host device.



@SETUPT0
Do Not Transmit Programming Barcode Data



@SETUPT1
Transmit Programming Barcode Data



@SETUPE0
**** Exit Setup**



@SETUPE1
Enter Setup

Default Settings

Factory Defaults

Scanning the following barcode can restore the scanner to the factory defaults.

You may need to reset all parameters to the factory defaults when:

- ✧ scanner is not properly configured so that it fails to decode barcodes.
- ✧ you forget previous configuration and want to avoid its impact.



@FACDEF
Restore All Factory Defaults

Custom Defaults

Scanning the **Restore All Custom Defaults** barcode can reset all parameters to the custom defaults. Scanning the **Save as Custom Defaults** barcode can set the current settings as custom defaults.

Custom defaults are stored in the non-volatile memory.



@CUSSAV
Save as Custom Defaults



@CUSDEF
Restore All Custom Defaults



Restoring the scanner to the factory defaults will not remove the custom defaults from the scanner.



@SETUPE0
**** Exit Setup**



@SETUPE1
Enter Setup

Query Product Information

After scanning the barcode below, the product information (including product name, firmware version, decoder version, hardware version, serial number, OEM serial number and manufacturing date) will be sent to the host device.



@QRYSYS
Query Product Information

Query Product Name



@QRYPDN
Query Product Name

Query Firmware Version



@QRYFWV
Query Firmware Version



@SETUPE0
**** Exit Setup**



@SETUPE1
Enter Setup

Query Decoder Version



@QRYDCV
Query Decoder Version

Query Hardware Version



@QRYHWW
Query Hardware Version

Query Product Serial Number



@QRYPSN
Query Product Serial Number



@SETUPE0
**** Exit Setup**



@SETUPE1
Enter Setup

Query Manufacturing Date



@QRYDAT
Query Manufacturing Date

Query OEM Serial Number



@QRYESN
Query OEM Serial Number

Query Data Formatter Version



@QRYDFM
Query Data Formatter Version



@SETUPE0
**** Exit Setup**



@SETUPE1
Enter Setup

Chapter 8 Communication Interface

Introduction

- ✧ Serial communication interface is usually used when connecting the scanner to a host device (like PC, POS). You need to set communication parameters to match the host device.



@SETUPE0
** Exit Setup



@SETUPE1
Enter Setup

RS-232 Interface

Serial communication interface is usually used when connecting the scanner to a host device (like PC, POS). However, to ensure smooth communication and accuracy of data, you need to set communication parameters (including baud rate, parity check, data bit and stop bit) to match the host device.



@INTERF0
RS-232



@SETUPE0
**** Exit Setup**



@SETUPE1
Enter Setup

Baud Rate

Baud rate is the number of bits of data transmitted per second. Set the baud rate to match the host requirements.



@232BAD8
115200



@232BAD7
57600



@232BAD6
38400



@232BAD5
19200



@232BAD4
14400



@232BAD3
9600



@232BAD2
4800

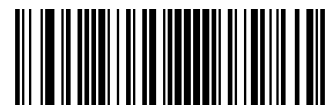

@SETUPE0
**** Exit Setup**



@SETUPE1
Enter Setup



@232BAD1
2400



@232BAD0
1200

Parity Check

Set the parity type to match the host requirements.

Odd Parity: If the data contains an odd number of 1 bits, the parity bit value is set to 0.

Even Parity: If the data contains an even number of 1 bits, the parity bit value is set to 0.

None: Select this option when no parity bit is required.



@232PAR0
None



@232PAR1
Even Parity



@232PAR2
Odd Parity



@SETUPE0
**** Exit Setup**



@SETUPE1
Enter Setup

Data Bit

Set the number of data bits to match the host requirements.



@232DAT1
7 Data Bits



@232DAT0
8 Data Bits

Stop Bit

The stop bit(s) at the end of each transmitted character marks the end of transmission of one character and prepares the receiving device for the next character in the serial data stream. Set the number of stop bits to match the host requirements.



@232STP0
1 Stop Bit



@232STP1
2 Stop Bits



@SETUPE0
**** Exit Setup**



@SETUPE1
Enter Setup

Chapter 9 System Settings

Scan Mode

Level Mode: A trigger pull activates a decode session. The decode session continues until a barcode is decoded or you release the trigger.

Continuous Mode: The scanner automatically starts one decode session after another. To suspend/resume barcode reading, simply press the trigger. **Reread Timeout** can avoid undesired rereading of same barcode in a given period of time.



@SCNMOD0
Level Mode



@SCNMOD3
Continuous Mode

Decode Session Timeout

This parameter sets the maximum time decode session continues during a scan attempt. It is programmable in 1ms increments from 1ms to 3,600,000ms. When it is set to 0, the timeout is infinite. This feature is only applicable to the Pulse, Sense and Level modes.

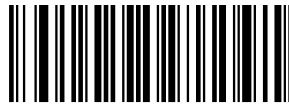

@ORTSET
Decode Session Timeout



@SETUPE0
** Exit Setup



@SETUPE1

Enter Setup



Set the decode session timeout to 1,500ms:

1. Scan the **Enter Setup** barcode.
2. Scan the **Decode Session Timeout** barcode.
3. Scan the numeric barcodes “1”, “5”, “0” and “0” from the “Digit Barcodes” section in Appendix.
4. Scan the **Save** barcode from the “Save/Cancel Barcodes” section in Appendix.
5. Scan the **Exit Setup** barcode.

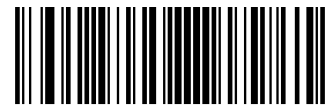

@SETUPE0

**** Exit Setup**



@SETUPE1
Enter Setup

Reread Timeout

Reread Timeout can avoid undesired rereading of same barcode in a given period of time. This feature is only applicable to the Sense and Continuous modes.

To enable/disable the Reread Timeout, scan the appropriate barcode below.

Enable Reread Timeout: Do not allow the scanner to re-read same barcode before the reread timeout expires.

Disable Reread Timeout: Allow the scanner to re-read same barcode.



@RRDENA1
Enable Reread Timeout



@RRDENA0
Disable Reread Timeout

The following parameter sets the time interval between two successive reads on same barcode. It is programmable in 1ms increments from 0ms to 3,600,000ms. When it is set to a value greater than 3,000, the timeout for rereading same programming barcode is limited to 3,000ms.



@RRDDUR
Reread Timeout



Set the reread timeout to 1,000ms:

1. Scan the **Enter Setup** barcode.
2. Scan the **Reread Timeout** barcode.
3. Scan the numeric barcodes “1”, “0”, “0” and “0” from the “Digit Barcodes” section in Appendix.
4. Scan the **Save** barcode from the “Save/Cancel Barcodes” section in Appendix.
5. Scan the **Exit Setup** barcode.



@SETUPE0
** Exit Setup



@SETUPE1
Enter Setup

You may wish to restart the reread timeout when the scanner encounters the same barcode that was decoded in the last scan session before the reread timeout expires. To enable this feature, scan the **Reread Timeout Reset On** barcode. This feature is only effective when **Reread Timeout** is enabled.



@RRDREN1
Reread Timeout Reset On



@RRDRENO
Reread Timeout Reset Off



@SETUPE0
**** Exit Setup**



@SETUPE1
Enter Setup

Good Read Delay

Good Read Delay sets the minimum amount of time before the scanner can read another barcode after a good read. This parameter is programmable in 1ms increments from 1ms to 3,600,000ms. Scan the appropriate barcode below to enable or disable the delay.



@GRDNA1
Enable Good Read Delay



@GRDNA0
Disable Good Read Delay

To set the good read delay, scan the barcode below, then set the delay (from 1 to 3,600,000ms) by scanning the digit barcode(s) then scanning the **Save** barcode from the Appendix.

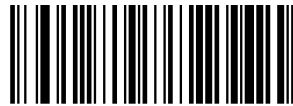

@GRDDUR
Good Read Delay



Set the good read delay to 1,000ms:

1. Scan the **Enter Setup** barcode.
2. Scan the **Good Read Delay** barcode.
3. Scan the numeric barcodes “1”, “0”, “0” and “0” from the “Digit Barcodes” section in Appendix.
4. Scan the **Save** barcode from the “Save/Cancel Barcodes” section in Appendix.
5. Scan the **Exit Setup** barcode.



@SETUPE0
**** Exit Setup**



@SETUPE1
Enter Setup

Bad Read Message

Scan the appropriate barcode below to select whether or not to send a bad read message (user-programmable) when a good read does not occur before trigger release, or the decode session timeout expires, or the scanner receives the **Stop Scanning** command (For more information, see the “Serial Trigger Command” section in this Chapter).



@NGRENA0
Bad Read Message OFF



@NGRENA1
Bad Read Message ON

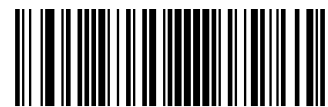

@SETUPE0
**** Exit Setup**



@SETUPE1
Enter Setup

Set Bad Read Message

A bad read message can contain up to 7 characters (HEX values from 0x00 to 0xFF). To set a bad read message, scan the **Set Bad Read Message** barcode, the numeric barcodes representing the hexadecimal values of desired character(s) and the **Save** barcode.



@NGRSET
Set Bad Read Message



Set the bad read message to “F” (HEX: 0x46):

1. Scan the **Enter Setup** barcode.
2. Scan the **Set Bad Read Message** barcode.
3. Scan the numeric barcodes “4” and “6” from the “Digit Barcodes” section in Appendix.
4. Scan the **Save** barcode from the “Save/Cancel Barcodes” section in Appendix.
5. Scan the **Exit Setup** barcode.

Trigger Commands

When **Enable Trigger Commands** is selected, you can activate and deactivate the scanner in the Level mode with serial trigger commands. Sending the **Start Scanning** command (default: <SOH> T <EOT>, user-programmable) to the scanner in the Level mode activates a decode session. The decode session continues until a barcode is decoded or the decode session timeout expires or the scanner receives the **Stop Scanning** command (default: <SOH> P <EOT>, user-programmable).



@SETUPE0
**** Exit Setup**



@SETUPE1
Enter Setup



@SCNTCE0
Disable Trigger Commands



@SCNTCE1
Enable Trigger Commands

Modify Start Scanning Command

The **Start Scanning** command can consist of 1-10 characters (HEX values from 0x01 to 0xFF). In this command, the character “?” (HEX: 0x3F) cannot be the first character. The default **Start Scanning** command is **<SOH> T <EOT>**.



@SCNTCT
Modify Start Scanning Command



Set the **Start Scanning** command to “*T”:

1. Scan the **Enter Setup** barcode.
2. Scan the **Modify Start Scanning Command** barcode.
3. Scan the numeric barcodes “2”, “A”, “5” and “4” from the “Digit Barcodes” section in Appendix.
4. Scan the **Save** barcode from the “Save/Cancel Barcodes” section in Appendix.
5. Scan the **Exit Setup** barcode.

Modify Stop Scanning Command

The **Stop Scanning** command can consist of 1-10 characters (HEX values from 0x01 to 0xFF). In this command, the character “?” (HEX: 0x3F) cannot be the first character. The default **Stop Scanning** command is **<SOH> P <EOT>**.

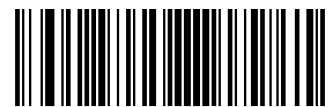

@SETUPE0
**** Exit Setup**



@SETUPE1
Enter Setup



@SCNTCP
Modify Stop Scanning Command



Set the Stop Scanning command to “*P”:

1. Scan the **Enter Setup** barcode.
2. Scan the **Modify Stop Scanning Command** barcode.
3. Scan the numeric barcodes “2”, “A”, “5” and “0” from the “Digit Barcodes” section in Appendix.
4. Scan the **Save** barcode from the “Save/Cancel Barcodes” section in Appendix.
5. Scan the **Exit Setup** barcode.



@SETUPE0
**** Exit Setup**



@SETUPE1
Enter Setup

Illumination

A couple of illumination options are provided to improve the lighting conditions during every image capture:

Normal: Illumination LEDs are turned on during image capture.

Off: Illumination LEDs are off all the time.



@ILLSCN1
Normal



@ILLSCN0
Off

Good Read LED

The green LED can be programmed to be On or Off to indicate good read.



@GRLENA1
On



@GRLENA0
Off



@SETUPE0
**** Exit Setup**



@SETUPE1
Enter Setup

Good Read LED Duration

This parameter sets the amount of time that the Good Read LED to remain on following a good read. It is programmable in 1ms increments from 1ms to 2,500ms.



@GRLDUR20
Short (20ms)



@GRLDUR120
Medium (120ms)



@GRLDUR220
Long (220ms)



@GRLDUR320
Prolonged (320ms)



@GRLDUR
Custom (1 - 2,500ms)



Set the Good Read LED duration to 800ms:

1. Scan the **Enter Setup** barcode.
2. Scan the **Custom** barcode.
3. Scan the numeric barcodes “8”, “0” and “0” from the “Digit Barcodes” section in Appendix.
4. Scan the **Save** barcode from the “Save/Cancel Barcodes” section in Appendix.
5. Scan the **Exit Setup** barcode.



@SETUPE0
**** Exit Setup**



@SETUPE1
Enter Setup

Security Level

This parameter sets decoding times that is required to correctly read the barcode. The higher the security level, the lower the decoding error rate, but the slower the speed.

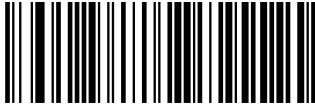

@SAFLVL0
Security Level 1



@SAFLVL2
Security Level 3



@SAFLVL1
Security Level 2



@SAFLVL3
Security Level 4



@SETUPE0
**** Exit Setup**



@SETUPE1
Enter Setup

Switching Input Signal

After Switching Input is enabled, there are two ways to trigger a decode session with a trigger pull as below.

Negative Slope

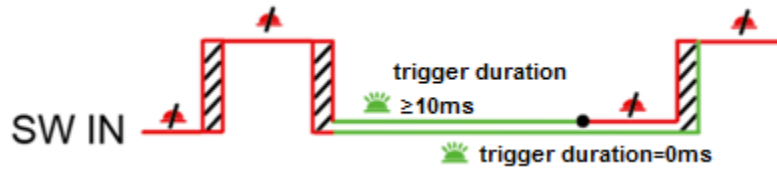

Positive Slope



LED off and decode session ends

LED on and decode session continues

Debounce time

Enable/Disable Switching Input



@TRGENA1
Enable Switching Input



@TRGENA0
Disable Switching Input



@SETUPE0
** Exit Setup



@SETUPE1
Enter Setup

Trigger Slope



@TRGSGN2
Positive Slope



@TRGSGN3
Negative Slope

Trigger Duration

This parameter sets the trigger duration during a decode session. Within trigger duration, the decode session continues until a barcode is decoded or you release the trigger. When it is set to 0, the time is infinite. This feature is only applicable to the Level mode.



@LCATDR
Trigger Duration



Set the Trigger Duration to 1000ms:

1. Scan the **Enter Setup** barcode.
2. Scan the **Trigger Duration** barcode.
3. Scan the numeric barcodes "1", "0", "0" and "0" from the "Digit Barcodes" section in Appendix.
4. Scan the **Save** barcode from the "Save/Cancel Barcodes" section in Appendix.
5. Scan the **Exit Setup** barcode.

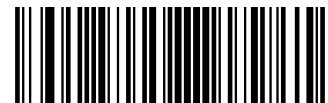

@SETUPE0
**** Exit Setup**



@SETUPE1

Enter Setup

Debounce Duration

This parameter sets the debounce duration after a trigger press. When the debounce time expires, the scanner triggers a decode session. The default setting is 10ms.



@TBDDUR

Debounce Duration



Set the Debounce Duration to 20ms:

1. Scan the **Enter Setup** barcode.
2. Scan the **Debounce Duration** barcode.
3. Scan the numeric barcodes “2” and “0” from the “Digit Barcodes” section in Appendix.
4. Scan the **Save** barcode from the “Save/Cancel Barcodes” section in Appendix.
5. Scan the **Exit Setup** barcode.



@SETUPE0

**** Exit Setup**



@SETUPE1
Enter Setup

Switching Output Signal

After Switching Output is enabled, there are two ways to output level after a successful or failed decode.

Output High Level

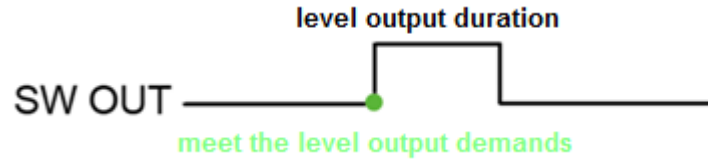

Output Low Level

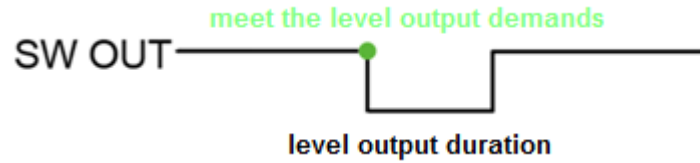

Enable/Disable Switching Output



@GRSENA1

Enable Switching Output



@GRSENA0

Disable Switching Output



@SETUPE0

** Exit Setup



@SETUPE1

Enter Setup

Output High/Low Level



@LCAAPL1

Output High Level



@LCAAPL0

Output Low Level

Output Duration

This parameter sets the level output duration after a successful or failed decode.



@LCAADR

Output Duration



Set the Output Duration to 500ms:

1. Scan the **Enter Setup** barcode.
2. Scan the **Output Duration** barcode.
3. Scan the numeric barcodes “5”, “0” and “0” from the “Digit Barcodes” section in Appendix.
4. Scan the **Save** barcode from the “Save/Cancel Barcodes” section in Appendix.
5. Scan the **Exit Setup** barcode.



@SETUPE0

**** Exit Setup**



@SETUPE1

Enter Setup

Enable Level Output

Level output is enabled after a successful or failed decode. The configuration format is LCAATCmSnF.

m=1: it indicates the scanner produces high/low level after a good read.

m=0: it indicates the scanner doesn't produce high/low level after a good read.

n=1: it indicates the scanner produces high/low level after a failed read.

n=0: it indicates the scanner doesn't produce high/low level after a failed read.



@LCAATC1S0F

Output Level After a Good Read



@LCAATC0S1F

Output Level After a Failed Read



@LCAATC1S1F

Output Level After a Good or Failed Read



@LCAATC0S0F

Do Not Output Level



@SETUPE0

**** Exit Setup**



@SETUPE1
Enter Setup

Stop Level Output

Stop level output when another decode session starts or ends. The configuration format is LCADACmEnB.

m=1: it indicates the scanner stop producing high or low level when another decode session ends.

m=0: it indicates the scanner continues producing high or low level when another decode session ends.

n=1: it indicates the scanner stop producing high or low level when another decode session starts.

n=0: it indicates the scanner continues producing high or low level when another decode session starts.



@LCADAC1E0B

Stop Level Output When Another Decode Session Ends



@LCADAC0E1B

Stop Level Output When Another Decode Session Starts



@LCADAC0E0B

Do Not Stop Level Output



@SETUPE0
**** Exit Setup**



@SETUPE1
Enter Setup

Chapter 10 Symbologies

Introduction

Every symbology (barcode type) has its own unique attributes. This chapter provides programming barcodes for configuring the scanner so that it can identify various symbologies. It is recommended to disable those that are rarely used to increase the efficiency of the scanner.

Global Settings

Enable/Disable All Symbologies

If the **Disable All Symbologies** feature is enabled, the scanner will not be able to read any non-programming barcodes except the programming barcodes.



@ALLENA1
Enable All Symbologies



@ALLENA0
Disable All Symbologies

Enable/Disable 1D Symbologies



@ALL1DC1
Enable 1D Symbologies



@ALL1DC0
Disable 1D Symbologies



@SETUPE0
** Exit Setup



@SETUPE1
Enter Setup

Surround GS1 Application Identifiers (AI's) with Parentheses

When **Surround GS1 AI's with Parentheses** is selected, each application identifier (AI) contained in scanned data will be enclosed in parentheses in the output message.



@GS1AIP0

Do Not Surround GS1 AI's with Parentheses



@GS1AIP1

Surround GS1 AI's with Parentheses

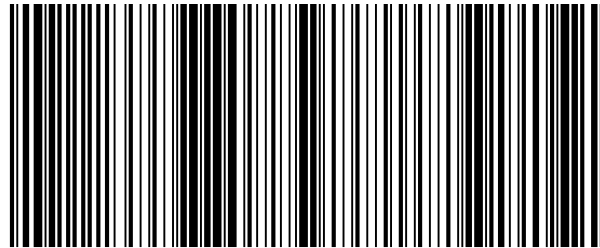

(01) 0 0614141 99999 6 (10) 10ABCEDF123456

If **Surround GS1 AI's with Parentheses** is selected, the barcode above is output as (01)0614141999996(10)10ABCEDF123456.

If **Do Not Surround GS1 AI's with Parentheses** is selected, the barcode above is output as 01006141419999961010ABCEDF123456.



@SETUPE0
** Exit Setup



@SETUPE1
Enter Setup

Code 128

Restore Factory Defaults



@128DEF

Restore the Factory Defaults of Code 128

Enable/Disable Code 128



@128ENA1

Enable Code 128



@128ENA0

Disable Code 128



If the scanner fails to identify Code 128 barcodes, you may first try this solution by scanning the **Enter Setup** barcode and then **Enable Code 128** barcode.

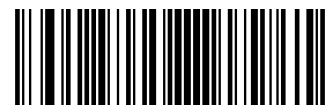

@SETUPE0
**** Exit Setup**



@SETUPE1
Enter Setup

Set Length Range for Code 128

The scanner can be configured to only decode Code 128 barcodes with lengths that fall between (inclusive) the minimum and maximum lengths. To accomplish it, you need to set the minimum and maximum lengths.



@128MIN
Set the Minimum Length



@128MAX
Set the Maximum Length



If minimum length is set to be greater than maximum length, the scanner only decodes Code 128 barcodes with either the minimum or maximum length. If minimum length is same as maximum length, only Code 128 barcodes with that length are to be decoded.



Set the scanner to decode Code 128 barcodes containing between 8 and 12 characters:

1. Scan the **Enter Setup** barcode.
2. Scan the **Set the Minimum Length** barcode.
3. Scan the numeric barcode “8” from the “Digit Barcodes” section in Appendix.
4. Scan the **Save** barcode from the “Save/Cancel Barcodes” section in Appendix.
5. Scan the **Set the Maximum Length** barcode.
6. Scan the numeric barcodes “1” and “2” from the “Digit Barcodes” section in Appendix.
7. Scan the **Save** barcode from the “Save/Cancel Barcodes” section in Appendix.
8. Scan the **Exit Setup** barcode.



@SETUPE0
**** Exit Setup**



@SETUPE1
Enter Setup

EAN-8

Restore Factory Defaults



@EA8DEF

Restore the Factory Defaults of EAN-8

Enable/Disable EAN-8



@EA8ENA1

Enable EAN-8



@EA8ENA0

Disable EAN-8



If the scanner fails to identify EAN-8 barcodes, you may first try this solution by scanning the **Enter Setup** barcode and then **Enable EAN-8** barcode.

Transmit Check Character

EAN-8 is 8 digits in length with the last one as its check character used to verify the integrity of the data.



@EA8CHK2

Transmit EAN-8 Check Character



@EA8CHK1

Do Not Transmit EAN-8 Check Character



@SETUPE0

** Exit Setup



@SETUPE1
Enter Setup

2-Digit Add-On Code

An EAN-8 barcode can be augmented with a two-digit add-on code to form a new one. In the example below, the part surrounded by blue dotted line is an EAN-8 barcode while the part circled by red dotted line is a two-digit add-on code.



@EA8AD20
Disable 2-Digit Add-On Code



@EA8AD21
Enable 2-Digit Add-On Code



Disable 2-Digit Add-On Code: The scanner decodes EAN-8 and ignores the add-on code when presented with an EAN-8 plus 2-digit add-on barcode. It can also decode EAN-8 barcodes without 2-digit add-on codes.

Enable 2-Digit Add-On Code: The scanner decodes a mix of EAN-8 barcodes with and without 2-digit add-on codes.



@SETUPE0
** Exit Setup



@SETUPE1

Enter Setup

5-Digit Add-On Code

An EAN-8 barcode can be augmented with a five-digit add-on code to form a new one. In the example below, the part surrounded by blue dotted line is an EAN-8 barcode while the part circled by red dotted line is a five-digit add-on code.



@EA8AD50

Disable 5-Digit Add-On Code



@EA8AD51

Enable 5-Digit Add-On Code



Disable 5-Digit Add-On Code: The scanner decodes EAN-8 and ignores the add-on code when presented with an EAN-8 plus 5-digit add-on barcode. It can also decode EAN-8 barcodes without 5-digit add-on codes.

Enable 5-Digit Add-On Code: The scanner decodes a mix of EAN-8 barcodes with and without 5-digit add-on codes.



@SETUPE0

** Exit Setup



@SETUPE1
Enter Setup

Add-On Code Required

When **EAN-8 Add-On Code Required** is selected, the scanner will only read EAN-8 barcodes that contain add-on codes.



@EA8REQ0
EAN-8 Add-On Code Not Required



@EA8REQ1
EAN-8 Add-On Code Required

Convert EAN-8 to EAN-13

Convert EAN-8 to EAN-13: Convert EAN-8 decoded data to EAN-13 format before transmission. After conversion, the data follows EAN-13 format and is affected by EAN-13 programming selections (e.g., Check Character).

Do Not Convert EAN-8 to EAN-13: EAN-8 decoded data is transmitted as EAN-8 data, without conversion.



@EA8EXP0
Do Not Convert EAN-8 to EAN-13



@EA8EXP1
Convert EAN-8 to EAN-13



@SETUPE0
**** Exit Setup**



@SETUPE1
Enter Setup

EAN-13

Restore Factory Defaults



@E13DEF

Restore the Factory Defaults of EAN-13

Enable/Disable EAN-13



@E13ENA1

Enable EAN-13



@E13ENA0

Disable EAN-13



If the scanner fails to identify EAN-13 barcodes, you may first try this solution by scanning the **Enter Setup** barcode and then **Enable EAN-13** barcode.



@SETUPE0
**** Exit Setup**



@SETUPE1
Enter Setup

Transmit Check Character



@E13CHK2

Transmit EAN-13 Check Character



@E13CHK1

Do Not Transmit EAN-13 Check Character

2-Digit Add-On Code

An EAN-13 barcode can be augmented with a two-digit add-on code to form a new one. In the example below, the part surrounded by blue dotted line is an EAN-13 barcode while the part circled by red dotted line is a two-digit add-on code.



@E13AD20

Disable 2-Digit Add-On Code



@E13AD21

Enable 2-Digit Add-On Code



Disable 2-Digit Add-On Code: The scanner decodes EAN-13 and ignores the add-on code when presented with an EAN-13 plus 2-digit add-on barcode. It can also decode EAN-13 barcodes without 2-digit add-on codes.

Enable 2-Digit Add-On Code: The scanner decodes a mix of EAN-13 barcodes with and without 2-digit add-on codes.



@SETUPE0
** Exit Setup



@SETUPE1
Enter Setup

5-Digit Add-On Code

An EAN-13 barcode can be augmented with a five-digit add-on code to form a new one. In the example below, the part surrounded by blue dotted line is an EAN-13 barcode while the part circled by red dotted line is a five-digit add-on code.



Disable 5-Digit Add-On Code



Enable 5-Digit Add-On Code



Disable 5-Digit Add-On Code: The scanner decodes EAN-13 and ignores the add-on code when presented with an EAN-13 plus 5-digit add-on barcode. It can also decode EAN-13 barcodes without 5-digit add-on codes.

Enable 5-Digit Add-On Code: The scanner decodes a mix of EAN-13 barcodes with and without 5-digit add-on codes.

Add-On Code Required

When **EAN-13 Add-On Code Required** is selected, the scanner will only read EAN-13 barcodes that contain add-on codes.



EAN-13 Add-On Code Not Required



EAN-13 Add-On Code Required



@SETUPE0
**** Exit Setup**



@SETUPE1
Enter Setup

UPC-E

Restore Factory Defaults

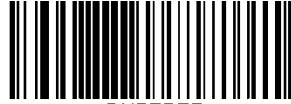

@UPEDEF
Restore the Factory Defaults of UPC-E

Enable/Disable UPC-E



@UPEENA1
Enable UPC-E



@UPEENA0
Disable UPC-E



If the scanner fails to identify UPC-E barcodes, you may first try this solution by scanning the **Enter Setup** barcode and then **Enable UPC-E** barcode.



@SETUPE0
**** Exit Setup**



@SETUPE1

Enter Setup

Transmit Check Character

UPC-E is 8 digits in length with the last one as its check character used to verify the integrity of the data.



@UPECHK2

Transmit UPC-E Check Character



@UPECHK1

Do Not Transmit UPC-E Check Character

2-Digit Add-On Code

A UPC-E barcode can be augmented with a two-digit add-on code to form a new one. In the example below, the part surrounded by blue dotted line is a UPC-E barcode while the part circled by red dotted line is a two-digit add-on code.



@UPEAD20

Disable 2-Digit Add-On Code



@UPEAD21

Enable 2-Digit Add-On Code



Disable 2-Digit Add-On Code: The scanner decodes UPC-E and ignores the add-on code when presented with a UPC-E plus 2-digit add-on barcode. It can also decode UPC-E barcodes without 2-digit add-on codes.

Enable 2-Digit Add-On Code: The scanner decodes a mix of UPC-E barcodes with and without 2-digit add-on codes.



@SETUPE0

** Exit Setup



@SETUPE1
Enter Setup

5-Digit Add-On Code

A UPC-E barcode can be augmented with a five-digit add-on code to form a new one. In the example below, the part surrounded by blue dotted line is a UPC-E barcode while the part circled by red dotted line is a five-digit add-on code.



@UPEAD50
Disable 5-Digit Add-On Code



@UPEAD51
Enable 5-Digit Add-On Code



Disable 5-Digit Add-On Code: The scanner decodes UPC-E and ignores the add-on code when presented with a UPC-E plus 5-digit add-on barcode. It can also decode UPC-E barcodes without 5-digit add-on codes.

Enable 5-Digit Add-On Code: The scanner decodes a mix of UPC-E barcodes with and without 5-digit add-on codes.

Add-On Code Required

When **UPC-E Add-On Code Required** is selected, the scanner will only read UPC-E barcodes that contain add-on codes.



@UPEREQ0
UPC-E Add-On Code Not Required



@UPEREQ1
UPC-E Add-On Code Required



@SETUPE0
** Exit Setup



@SETUPE1
Enter Setup

Transmit Preamble Character

Preamble characters (Country Code and System Character) can be transmitted as part of a UPC-E barcode. Select one of the following options for transmitting UPC-E preamble to the host device: transmit system character only, transmit system character and country code ("0" for USA), or transmit no preamble.



@UPEPRE1
System Character



@UPEPRE0
No Preamble



@UPEPRE2
System Character & Country Code

Convert UPC-E to UPC-A

Convert UPC-E to UPC-A: Convert UPC-E (zero suppressed) decoded data to UPC-A format before transmission. After conversion, the data follows UPC-A format and is affected by UPC-A programming selections (e.g., Preamble, Check Character).

Do Not Convert UPC-E to UPC-A: UPC-E decoded data is transmitted as UPC-E data, without conversion.

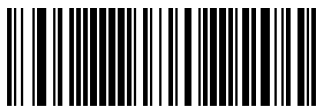

@UPEEXP0
Do Not Convert UPC-E to UPC-A



@UPEEXP1
Convert UPC-E to UPC-A

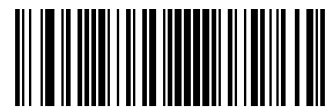

@SETUPE0
** Exit Setup



@SETUPE1
Enter Setup

UPC-A

Restore Factory Defaults



@UPADEF
Restore the Factory Defaults of UPC-A

Enable/Disable UPC-A



@UPAENA1
Enable UPC-A



@UPAENA0
Disable UPC-A



If the scanner fails to identify UPC-A barcodes, you may first try this solution by scanning the **Enter Setup** barcode and then **Enable UPC-A** barcode.

Transmit Check Character

UPC-A is 13 digits in length with the last one as its check character used to verify the integrity of the data.



@UPACHK2
Transmit UPC-A Check Character



@UPACHK1
Do Not Transmit UPC-A Check Character



@SETUPE0
** Exit Setup



@SETUPE1
Enter Setup

2-Digit Add-On Code

A UPC-A barcode can be augmented with a two-digit add-on code to form a new one. In the example below, the part surrounded by blue dotted line is a UPC-A barcode while the part circled by red dotted line is a two-digit add-on code.



@UPAAD20
Disable 2-Digit Add-On Code



@UPAAD21
Enable 2-Digit Add-On Code



Disable 2-Digit Add-On Code: The scanner decodes UPC-A and ignores the add-on code when presented with a UPC-A plus 2-digit add-on barcode. It can also decode UPC-A barcodes without 2-digit add-on codes.

Enable 2-Digit Add-On Code: The scanner decodes a mix of UPC-A barcodes with and without 2-digit add-on codes.



@SETUPE0
** Exit Setup



@SETUPE1
Enter Setup

5-Digit Add-On Code

A UPC-A barcode can be augmented with a five-digit add-on code to form a new one. In the example below, the part surrounded by blue dotted line is a UPC-A barcode while the part circled by red dotted line is a five-digit add-on code.



@UPAAD50
Disable 5-Digit Add-On Code



@UPAAD51
Enable 5-Digit Add-On Code



Disable 5-Digit Add-On Code: The scanner decodes UPC-A and ignores the add-on code when presented with a UPC-A plus 5-digit add-on barcode. It can also decode UPC-A barcodes without 5-digit add-on codes.

Enable 5-Digit Add-On Code: The scanner decodes a mix of UPC-A barcodes with and without 5-digit add-on codes.



@SETUPE0
** Exit Setup



@SETUPE1

Enter Setup

Add-On Code Required

When **UPC-A Add-On Code Required** is selected, the scanner will only read UPC-A barcodes that contain add-on codes.



@UPAREQ0

UPC-A Add-On Code Not Required



@UPAREQ1

UPC-A Add-On Code Required

Transmit Preamble Character

Preamble characters (Country Code and System Character) can be transmitted as part of a UPC-A barcode. Select one of the following options for transmitting UPC-A preamble to the host device: transmit system character only, transmit system character and country code ("0" for USA), or transmit no preamble.



@UPAPRE0

No Preamble

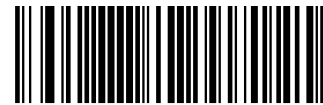

@UPAPRE1

System Character



@UPAPRE2

System Character & Country Code



@SETUPE0

**** Exit Setup**



@SETUPE1
Enter Setup

Interleaved 2 of 5

Restore Factory Defaults



@I25DEF
Restore the Factory Defaults of Interleaved 2 of 5

Enable/Disable Interleaved 2 of 5



@I25ENA1
Enable Interleaved 2 of 5



@I25ENA0
Disable Interleaved 2 of 5



If the scanner fails to identify Interleaved 2 of 5 barcodes, you may first try this solution by scanning the **Enter Setup** barcode and then **Enable Interleaved 2 of 5** barcode.



@SETUPE0
**** Exit Setup**



@SETUPE1
Enter Setup

Set Length Range for Interleaved 2 of 5

The scanner can be configured to only decode Interleaved 2 of 5 barcodes with lengths that fall between (inclusive) the minimum and maximum lengths. To accomplish it, you need to set the minimum and maximum lengths.



Set the Minimum Length



Set the Maximum Length



If minimum length is set to be greater than maximum length, the scanner only decodes Interleaved 2 of 5 barcodes with either the minimum or maximum length. If minimum length is same as maximum length, only Interleaved 2 of 5 barcodes with that length are to be decoded.



Set the scanner to decode Interleaved 2 of 5 barcodes containing between 8 and 12 characters:

1. Scan the **Enter Setup** barcode.
2. Scan the **Set the Minimum Length** barcode.
3. Scan the numeric barcode “8” from the “Digit Barcodes” section in Appendix.
4. Scan the **Save** barcode from the “Save/Cancel Barcodes” section in Appendix.
5. Scan the **Set the Maximum Length** barcode.
6. Scan the numeric barcodes “1” and “2” from the “Digit Barcodes” section in Appendix.
7. Scan the **Save** barcode from the “Save/Cancel Barcodes” section in Appendix.
8. Scan the **Exit Setup** barcode.

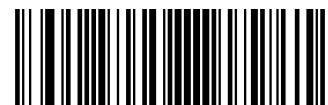

@SETUPE0
**** Exit Setup**



@SETUPE1
Enter Setup

Check Character Verification

A check character is optional for Interleaved 2 of 5 and can be added as the last character. It is a calculated value used to verify the integrity of the data.

- ✧ **Disable:** The scanner transmits Interleaved 2 of 5 barcodes as is.
- ✧ **Do Not Transmit Check Character After Verification:** The scanner checks the integrity of all Interleaved 2 of 5 barcodes to verify that the data complies with the check character algorithm. Barcodes passing the check will be transmitted except the last digit, whereas those failing it will not be transmitted.
- ✧ **Transmit Check Character After Verification:** The scanner checks the integrity of all Interleaved 2 of 5 barcodes to verify that the data complies with the check character algorithm. Barcodes passing the check will be transmitted, whereas those failing it will not be transmitted.

Since Interleaved 2 of 5 must always have an even number of digits, a zero may need to be added as the first digit when the check character is added. The check character is automatically generated when making Interleaved 2 of 5 barcodes.



@I25CHK0
Disable



@I25CHK1
Do Not Transmit Check Character After Verification



@I25CHK2
Transmit Check Character After Verification



If the **Do Not Transmit Check Character After Verification** option is enabled, Interleaved 2 of 5 barcodes with a length that is less than the configured minimum length after having the check character excluded will not be decoded. (For example, when the **Do Not Transmit Check Character After Verification** option is enabled and the minimum length is set to 4, Interleaved 2 of 5 barcodes with a total length of 4 characters including the check character cannot be read.)



@SETUPE0
**** Exit Setup**



@SETUPE1
Enter Setup

Code 39

Restore Factory Defaults



@C39DEF
Restore the Factory Defaults of Code 39

Enable/Disable Code 39



@C39ENA1
Enable Code 39



@C39ENA0
Disable Code 39



If the scanner fails to identify Code 39 barcodes, you may first try this solution by scanning the **Enter Setup** barcode and then **Enable Code 39** barcode.



@SETUPE0
**** Exit Setup**



@SETUPE1
Enter Setup

Set Length Range for Code 39

The scanner can be configured to only decode Code 39 barcodes with lengths that fall between (inclusive) the minimum and maximum lengths. To accomplish it, you need to set the minimum and maximum lengths.



@C39MIN
Set the Minimum Length



@C39MAX
Set the Maximum Length



If minimum length is set to be greater than maximum length, the scanner only decodes Code 39 barcodes with either the minimum or maximum length. If minimum length is same as maximum length, only Code 39 barcodes with that length are to be decoded.



Set the scanner to decode Code 39 barcodes containing between 8 and 12 characters:

1. Scan the **Enter Setup** barcode.
2. Scan the **Set the Minimum Length** barcode.
3. Scan the numeric barcode “8” from the “Digit Barcodes” section in Appendix.
4. Scan the **Save** barcode from the “Save/Cancel Barcodes” section in Appendix.
5. Scan the **Set the Maximum Length** barcode.
6. Scan the numeric barcodes “1” and “2” from the “Digit Barcodes” section in Appendix.
7. Scan the **Save** barcode from the “Save/Cancel Barcodes” section in Appendix.
8. Scan the **Exit Setup** barcode.



@SETUPE0
**** Exit Setup**



@SETUPE1
Enter Setup

Check Character Verification

A check character is optional for Code 39 and can be added as the last character. It is a calculated value used to verify the integrity of the data.

- ✧ **Disable:** The scanner transmits Code 39 barcodes as is.
- ✧ **Do Not Transmit Check Character After Verification:** The scanner checks the integrity of all Code 39 barcodes to verify that the data complies with the check character algorithm. Barcodes passing the check will be transmitted except the last digit, whereas those failing it will not be transmitted.
- ✧ **Transmit Check Character After Verification:** The scanner checks the integrity of all Code 39 barcodes to verify that the data complies with the check character algorithm. Barcodes passing the check will be transmitted, whereas those failing it will not be transmitted.



@C39CHK0
Disable



@C39CHK1
Do Not Transmit Check Character After Verification



@C39CHK2
Transmit Check Character After Verification



If the **Do Not Transmit Check Character After Verification** option is enabled, Code 39 barcodes with a length that is less than the configured minimum length after having the check character excluded will not be decoded. (For example, when the **Do Not Transmit Check Character After Verification** option is enabled and the minimum length is set to 4, Code 39 barcodes with a total length of 4 characters including the check character cannot be read.)

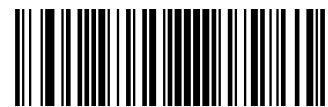

@SETUPE0
** Exit Setup



@SETUPE1
Enter Setup

Transmit Start/Stop Character

Code 39 uses an asterisk (*) for both the start and the stop characters. You can choose whether or not to transmit the start/stop characters by scanning the appropriate barcode below.



@C39TSC0

Do Not Transmit Start/Stop Character



@C39TSC1

Transmit Start/Stop Character

Enable/Disable Code 39 Full ASCII

The scanner can be configured to identify all ASCII characters by scanning the appropriate barcode below.



@C39ASC0

Disable Code 39 Full ASCII



@C39ASC1

Enable Code 39 Full ASCII



@SETUPE0
**** Exit Setup**



@SETUPE1
Enter Setup

Enable/Disable Code 32 (Italian Pharma Code)

Code 32 is a variant of Code 39 used by the Italian pharmaceutical industry. Scan the appropriate bar code below to enable or disable Code 32. Code 39 must be enabled and Code 39 check character verification must be disabled for this parameter to function.



@C39E320
Disable Code 32



@C39E321
Enable Code 32

Code 32 Prefix

Scan the appropriate barcode below to enable or disable adding the prefix character "A" to all Code 32 barcodes. Code 32 must be enabled for this parameter to function.



@C39S320
Disable Code 32 Prefix



@C39S321
Enable Code 32 Prefix

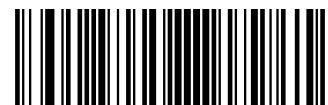

@SETUPE0
**** Exit Setup**



@SETUPE1
Enter Setup

Transmit Code 32 Start/Stop Character

Code 32 must be enabled for this parameter to function.



@C39T320

Do Not Transmit Code 32 Start/Stop Character



@C39T321

Transmit Code 32 Start/Stop Character

Transmit Code 32 Check Character

Code 32 must be enabled for this parameter to function.



@C39C320

Do Not Transmit Code 32 Check Character



@C39C321

Transmit Code 32 Check Character



@SETUPE0
** Exit Setup



@SETUPE1
Enter Setup

Codabar

Restore Factory Defaults



@CBADEF

Restore the Factory Defaults of Codabar

Enable/Disable Codabar



@CBAENA1

Enable Codabar



@CBAENA0

Disable Codabar



If the scanner fails to identify Codabar barcodes, you may first try this solution by scanning the **Enter Setup** barcode and then **Enable Codabar** barcode.

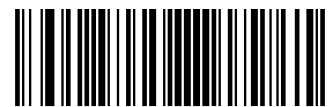

@SETUPE0
**** Exit Setup**



@SETUPE1
Enter Setup

Set Length Range for Codabar

The scanner can be configured to only decode Codabar barcodes with lengths that fall between (inclusive) the minimum and maximum lengths. To accomplish it, you need to set the minimum and maximum lengths.



@CBAMIN
Set the Minimum Length



@CBAMAX
Set the Maximum Length



If minimum length is set to be greater than maximum length, the scanner only decodes Codabar barcodes with either the minimum or maximum length. If minimum length is same as maximum length, only Codabar barcodes with that length are to be decoded.



Set the scanner to decode Codabar barcodes containing between 8 and 12 characters:

1. Scan the **Enter Setup** barcode.
2. Scan the **Set the Minimum Length** barcode.
3. Scan the numeric barcode “8” from the “Digit Barcodes” section in Appendix.
4. Scan the **Save** barcode from the “Save/Cancel Barcodes” section in Appendix.
5. Scan the **Set the Maximum Length** barcode.
6. Scan the numeric barcodes “1” and “2” from the “Digit Barcodes” section in Appendix.
7. Scan the **Save** barcode from the “Save/Cancel Barcodes” section in Appendix.
8. Scan the **Exit Setup** barcode.



@SETUPE0
**** Exit Setup**



@SETUPE1
Enter Setup

Check Character Verification

A check character is optional for Codabar and can be added as the last character. It is a calculated value used to verify the integrity of the data.

- ✧ **Disable:** The scanner transmits Codabar barcodes as is.
- ✧ **Do Not Transmit Check Character After Verification:** The scanner checks the integrity of all Codabar barcodes to verify that the data complies with the check character algorithm. Barcodes passing the check will be transmitted except the last digit, whereas those failing it will not be transmitted.
- ✧ **Transmit Check Character After Verification:** The scanner checks the integrity of all Codabar barcodes to verify that the data complies with the check character algorithm. Barcodes passing the check will be transmitted, whereas those failing it will not be transmitted.

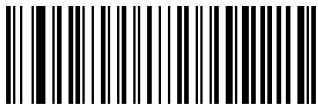

@CBACHK0
Disable



@CBACHK1
Do Not Transmit Check Character After Verification



@CBACHK2
Transmit Check Character After Verification



If the **Do Not Transmit Check Character After Verification** option is enabled, Codabar barcodes with a length that is less than the configured minimum length after having the check character excluded will not be decoded. (For example, when the **Do Not Transmit Check Character After Verification** option is enabled and the minimum length is set to 4, Codabar barcodes with a total length of 4 characters including the check character cannot be read.)



@SETUPE0
** Exit Setup



@SETUPE1
Enter Setup

Start/Stop Character

You can set the start/stop characters and choose whether or not to transmit the start/stop characters by scanning the appropriate barcode below.



@CBATSC0
Do Not Transmit Start/Stop Character



@CBATSC1
Transmit Start/Stop Character



@CBASCF0
ABCD/ABCD as the Start/Stop Character



@CBASCF1
ABCD/TN*E as the Start/Stop Character



@CBASCF2
abcd/abcd as the Start/Stop Character



@CBASCF3
abcd/tn*e as the Start/Stop Character



@SETUPE0
** Exit Setup



@SETUPE1
Enter Setup

Code 93

Restore Factory Defaults



@C93DEF

Restore the Factory Defaults of Code 93

Enable/Disable Code 93



@C93ENA1

Enable Code 93



@C93ENA0

Disable Code 93



If the scanner fails to identify Code 93 barcodes, you may first try this solution by scanning the **Enter Setup** barcode and then **Enable Code 93** barcode.



@SETUPE0
**** Exit Setup**



@SETUPE1
Enter Setup

Set Length Range for Code 93

The scanner can be configured to only decode Code 93 barcodes with lengths that fall between (inclusive) the minimum and maximum lengths. To accomplish it, you need to set the minimum and maximum lengths.



@C93MIN
Set the Minimum Length



@C93MAX
Set the Maximum Length



If minimum length is set to be greater than maximum length, the scanner only decodes Code 93 barcodes with either the minimum or maximum length. If minimum length is same as maximum length, only Code 93 barcodes with that length are to be decoded.



Set the scanner to decode Code 93 barcodes containing between 8 and 12 characters:

1. Scan the **Enter Setup** barcode.
2. Scan the **Set the Minimum Length** barcode.
3. Scan the numeric barcode “8” from the “Digit Barcodes” section in Appendix.
4. Scan the **Save** barcode from the “Save/Cancel Barcodes” section in Appendix.
5. Scan the **Set the Maximum Length** barcode.
6. Scan the numeric barcodes “1” and “2” from the “Digit Barcodes” section in Appendix.
7. Scan the **Save** barcode from the “Save/Cancel Barcodes” section in Appendix.
8. Scan the **Exit Setup** barcode.



@SETUPE0
**** Exit Setup**



@SETUPE1
Enter Setup

GS1-128 (UCC/EAN-128)

Restore Factory Defaults



@GS1DEF

Restore the Factory Defaults of GS1-128

Enable/Disable GS1-128



@GS1ENA1

Enable GS1-128



@GS1ENA0

Disable GS1-128



If the scanner fails to identify GS1-128 barcodes, you may first try this solution by scanning the **EnterSetup** barcode and then **Enable GS1-128** barcode.



@SETUPE0
**** Exit Setup**



@SETUPE1
Enter Setup

Set Length Range for GS1-128

The scanner can be configured to only decode GS1-128 barcodes with lengths that fall between (inclusive) the minimum and maximum lengths. To accomplish it, you need to set the minimum and maximum lengths.



@GS1MIN
Set the Minimum Length



@GS1MAX
Set the Maximum Length



If minimum length is set to be greater than maximum length, the scanner only decodes GS1-128 barcodes with either the minimum or maximum length. If minimum length is same as maximum length, only GS1-128 barcodes with that length are to be decoded.



Set the scanner to decode GS1-128 barcodes containing between 8 and 12 characters:

1. Scan the **Enter Setup** barcode.
2. Scan the **Set the Minimum Length** barcode.
3. Scan the numeric barcode “8” from the “Digit Barcodes” section in Appendix.
4. Scan the **Save** barcode from the “Save/Cancel Barcodes” section in Appendix.
5. Scan the **Set the Maximum Length** barcode.
6. Scan the numeric barcodes “1” and “2” from the “Digit Barcodes” section in Appendix.
7. Scan the **Save** barcode from the “Save/Cancel Barcodes” section in Appendix.
8. Scan the **Exit Setup** barcode.



@SETUPE0
**** Exit Setup**



@SETUPE1
Enter Setup

Chapter 11 Data Formatter

Introduction

You may use the Data Formatter to modify the scanner’s output. For example, you can use the Data Formatter to insert characters at certain points in barcode data or to suppress/ replace/ send certain characters in barcode data as it is scanned.

Normally, when you scan a barcode, it gets outputted automatically; however, when you create a format, you must use a “send” command (see the “Send Commands” section in this chapter) within the format programming to output data. Multiple data formats can be programmed into the scanner. The maximum size of all data formats created is 2048 characters. By default, the data formatter is disabled. Enable it when required. If you have changed data format settings, and wish to clear all formats and return to the factory defaults, scan the **Default Data Format** code below.



@DFMDEF
Default Data Format

Add a Data Format

Data format is used to edit barcode data. When you create a data format, you must select one of the four labels (Format_0, Format_1, Format_2 and Format_3) for your data format, specify the application scope of data format (such as barcode type and data length) and include formatter commands. Multiple data formats may be created using the same label.

There are two methods to program a data format: Programming with barcodes and programming with serial commands.

Programming with Barcodes

The following explains how to program a data format by scanning the specific barcodes. Scanning any irrelevant barcode or failing to follow the setting procedure will result in programming failure. To find the alphanumeric barcodes needed to create a data format, see the “Digit Barcodes” section in Appendix.

Step 1: Scan the **Enter Setup** barcode.



@SETUPE0
** Exit Setup



@SETUPE1
Enter Setup

Step 2: Scan the **Add Data Format** barcode.



@DFMADD
Add Data Format

Step 3: Select a label (Format_0 or Format_1 or Format_2 or Format_3).

Scan a numeric barcode **0** or **1** or **2** or **3** to label this data format Format_0 or Format_1 or Format_2 or Format_3.

Step 4: Select formatter command type.

Specify what type of formatter commands will be used. Scan a numeric barcode **6** to select formatter command type 6. (See the “Formatter Command Type 6” section in this chapter for more information)

Step 5: Set interface type

Scan **999** for any interface type.

Step 6: Set Symbology ID Number

Refer to the “Symbology ID Number” section in Appendix and find the ID number of the symbology to which you want to apply the data format. Scan three numeric barcodes for the symbology ID number. If you wish to create a data format for all symbologies, scan **999**.

Step 7: Set barcode data length

Specify what length of data will be acceptable for this symbology. Scan the four numeric barcodes that represent the data length. 9999 is a universal number, indicating all lengths. For example, 32 characters should be entered as 0032.

Step 8: Enter formatter command

Refer to the “Formatter Command Type 6” section in this chapter. Scan the alphanumeric barcodes that represent the command you need to edit data. For example, when a command is F141, you should scan F141.

Step 9: Scan the **Save** barcode from the “Save/Cancel Barcodes” section in Appendix to save your data format.



@SETUPE0
**** Exit Setup**



@SETUPE1
Enter Setup

Example: Program a Format_0 data format using formatter command type 6, Code 128 containing 10 characters applicable, send all characters followed by "A".

- | | |
|---|---|
| 1. Scan the Enter Setup barcode | Enter the Setup mode |
| 2. Scan the Add Data Format barcode | Add a data format |
| 3. Scan the 0 barcode | Select Format_0 as the label |
| 4. Scan the 6 barcode | Select formatter command type 6 |
| 5. Scan the 9 barcode three times | All interface types applicable |
| 6. Scan the barcodes 002 | Only Code 128 applicable |
| 7. Scan the barcodes 0010 | Only a length of 10 characters applicable |
| 8. Scan the alphanumeric barcodes F141 | Send all characters followed by "A" (HEX: 41) |
| 9. Scan the Save barcode | Save the data format |

To streamline the programming process, you may as well generate a batch barcode by inputting the command (e.g. **@DFMADD069990020010F141**;) used to create a data format. See the "Use Batch Barcode" section in Chapter 9 to learn how to put a batch barcode into use.

When creating multiple data formats sharing a label, the formats are separated from each other by a vertical bar (|) in the batch command, e.g. **@DFMADD069990029999F141|069990039999F142|169990049999F143**;

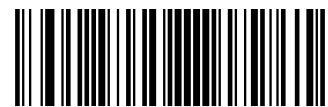

@SETUPE0
**** Exit Setup**



@SETUPE1
Enter Setup

Programming with Serial Commands

A data format can also be created by serial commands (HEX) sent from the host device. **All commands must be entered in uppercase letters.**

The syntax consists of the following elements:

Prefix: "~<SOH>0000" (HEX: **7E 01 30 30 30 30**), 6 characters.

Storage type: "@" (HEX: **40**) or "#" (HEX: **23**), 1 character. "@" means permanent setting which will not be lost by removing power from the scanner or rebooting it; "#" means temporary setting which will be lost by removing power from the scanner or rebooting it.

Add Data Format Command: "DFMADD" (HEX: **44 46 4D 41 44 44**), 6 characters.

Data format label: "0" (HEX: **30**) or "1" (HEX: **31**) or "2" (HEX: **32**) or "3" (HEX: **33**), 1 character. "0", "1", "2" and "3" represent Format_0, Format_1, Format_2 and Format_3 respectively.

Formatter command type: "6" (HEX: **36**), 1 character.

Interface type: "999" (HEX: **39 39 39**), 3 characters.

Symbology ID Number: The ID number of the symbology to which you want to apply the data format, 3 characters. 999 indicates all symbologies.

Data length: The length of data that will be acceptable for this symbology, 4 characters. 9999 indicates all lengths. For example, 32 characters should be entered as 0032.

Formatter commands: The command string used to edit data. For more information, see the "Formatter Command Type 6" section in this chapter.

Suffix: ";<ETX>" (HEX: **3B 03**), 2 characters.

Example: Program a Format_0 data format using formatter command type 6, Code 128 containing 10 characters applicable, send all characters followed by "A".

Enter: **7E 01 30 30 30 30 40 44 46 4D 41 44 44 30 36 39 39 39 30 30 33 39 39 39 39 46 31 34 31 3B 03**
(~<SOH>0000@DFMADD069990020010F141;<ETX>)

Response: **02 01 30 30 30 30 40 44 46 4D 41 44 44 30 36 39 39 39 30 30 33 39 39 39 39 46 31 34 31 06 3B 03**
(<STX><SOH>0000@DFMADD069990020010F141<ACK>;<ETX>)

When creating multiple data formats sharing a label, the formats are separated from each other by a vertical bar (|) in the serial command.

Example: ~<SOH>0000@DFMADD069990020010F141|069990039999F142|069990049999F143;<ETX>



@SETUPE0
** Exit Setup



@SETUPE1

Enter Setup

Enable/Disable Data Formatter

When Data Formatter is disabled, the data format you have enabled becomes invalid.



@DFMENA0

Disable Data Formatter

You may wish to require the data to conform to a data format you have created. The following settings can be applied to your data format:

Enable Data Formatter, Required, Keep Prefix/Suffix: Scanned data that meets your data format requirements is modified accordingly and gets outputted along with prefixes and suffixes (if prefix and suffix are enabled).

Enable Data Formatter, Required, Drop Prefix/Suffix: Scanned data that meets your data format requirements is modified accordingly and gets outputted without prefixes and suffixes (even if prefix and suffix are enabled).

Enable Data Formatter, Not Required, Keep Prefix/Suffix: Scanned data that meets your data format requirements is modified accordingly and gets outputted along with prefixes and suffixes (if prefix and suffix are enabled). Barcode data that does not match your data format requirements is transmitted as read along with prefixes and suffixes (if prefix and suffix are enabled).

Enable Data Formatter, Not Required, Drop Prefix/Suffix: Scanned data that meets your data format requirements is modified accordingly and gets outputted without prefixes and suffixes (even if prefix and suffix are enabled). Barcode data that does not match your data format requirements is transmitted as read along with prefixes and suffixes (if prefix and suffix are enabled).

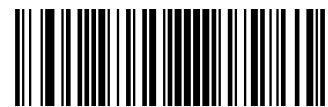

@SETUPE0

** Exit Setup



@SETUPE1
Enter Setup



@DFMENA1
Enable Data Formatter, Required, Keep Prefix/Suffix



@DFMENA2
Enable Data Formatter, Required, Drop Prefix/Suffix



@DFMENA3
Enable Data Formatter, Not Required, Keep Prefix/Suffix



@DFMENA4
Enable Data Formatter, Not Required, Drop Prefix/Suffix

Data Format Selection

After enabling the Data Formatter, you can select a data format you want to use by scanning the appropriate barcode below.



@SETUPE0
**** Exit Setup**



@SETUPE1
Enter Setup



@DFMUSE0
Format_0



@DFMUSE1
Format_1



@DFMUSE2
Format_2



@DFMUSE3
Format_3



@SETUPE0
**** Exit Setup**



@SETUPE1
Enter Setup

Change Data Format for a Single Scan

You can switch between data formats for a single scan. The next barcode is scanned using the data format selected here, then reverts to the format you have selected above.

For example, you may have set your scanner to use the data format you saved as Format_3. You can switch to Format_1 for a single trigger pull by scanning the **Single Scan – Format_1** barcode below. The next barcode that is scanned uses Format_1, then reverts back to Format_3.

Note: This setting will be lost by removing power from the scanner, or turning off/ rebooting the device.



@DFMSIN0
Single Scan – Format_0



@DFMSIN2
Single Scan – Format_2



@DFMSIN1
Single Scan – Format_1



@DFMSIN3
Single Scan – Format_3



@SETUPE0
**** Exit Setup**



@SETUPE1
Enter Setup

Clear Data Format

There are two methods to remove data format created from your scanner:

Delete one data format: Scan the **Clear One** barcode, a numeric barcode (0-3) and the **Save** barcode. For example, to delete Format_2, you should scan the **Clear One** barcode, the **2** barcode and the **Save** barcode

Delete all data formats: Scan the **Clear All** barcode.



@DFMCAL
Clear All



@DFMCLR
Clear One

Query Data Formats

You may scan the appropriate barcode below to get the information of data format(s) created by you or preset by manufacturer. For instance, if you have added Format_0 as per the example in the “Add a Data Format” section in this chapter, scanning the **Query Current Data Formats** barcode, you will get the result: **Data Format0:069990020010F141;**



@DFMQCU
Query Current Data Formats



@DFMQFA
Query Preset Data Formats



@SETUPE0
** Exit Setup



@SETUPE1
Enter Setup

Formatter Command Type 6

When working with the Data Formatter, a virtual cursor is moved along your input data string. The following commands are used to both move this cursor to different positions, and to select, replace, and insert data into the final output. For the hex value of ASCII characters involved in the commands, refer to the “ASCII Table” in Appendix.

Send Commands

F1 Send all characters

Syntax=F1xx (xx: The insert character’s hex value)

Include in the output message all of the characters from the input message, starting from current cursor position, followed by an insert character.

F2 Send a number of characters

Syntax=F2nxx (nn: The numeric value (00-99) for the number of characters; xx: The insert character’s hex value)

Include in the output message a number of characters followed by an insert character. Start from the current cursor position and continue for “nn” characters or through the last character in the input message, followed by character “xx.”

F2 Example: Send a number of characters



Send the first 10 characters from the barcode above, followed by a carriage return.

Command string: **F2100D**

F2 is the “Send a number of characters” command

10 is the number of characters to send

0D is the hex value for a CR

The data is output as: **1234567890**

<CR>



@SETUPE0
** Exit Setup



@SETUPE1
Enter Setup

F3 Send all characters up to a particular character

Syntax=F3ssxx (ss: The particular character's hex value; xx: The insert character's hex value)

Include in the output message all characters from the input message, starting with the character at the current cursor position and continuing to, but not including, the particular character "ss," followed by character "xx." The cursor is moved forward to the "ss" character.

F3 Example: Send all characters up to a particular character



Using the barcode above, send all characters up to but not including "D," followed by a carriage return.

Command string: **F3440D**

F3 is the "Send all characters up to a particular character" command

44 is the hex value for a "D"

0D is the hex value for a CR

The data is output as: **1234567890ABC**
<CR>

E9 Send all but the last characters

Syntax=E9nn (nn: The numeric value (00-99) for the number of characters that will not be sent at the end of the message)

Include in the output message all but the last "nn" characters, starting from the current cursor position. The cursor is moved forward to one position past the last input message character included.

F4 Insert a character multiple times

Syntax=F4xxnn (xx: The insert character's hex value; nn: The numeric value (00-99) for the number of times it should be sent)

Send "xx" character "nn" times in the output message, leaving the cursor in the current position.



@SETUPE0
** Exit Setup



@SETUPE1
Enter Setup

E9 and F4 Example: Send all but the last characters, followed by 2 tabs



Send all characters except for the last 8 from the barcode above, followed by 2 tabs.

Command string: **E908F40902**

E9 is the “Send all but the last characters” command

08 is the number of characters at the end to ignore

F4 is the “Insert a character multiple times” command

09 is the hex value for a horizontal tab

02 is the number of time the tab character is sent

The data is output as: **1234567890AB<tab><tab>**

B3 Insert symbology name

Insert the name of the barcode’s symbology in the output message, without moving the cursor.

B4 Insert barcode length

Insert the barcode’s length in the output message, without moving the cursor. The length is expressed as a numeric string and does not include leading zeros.



@SETUPE0
**** Exit Setup**



@SETUPE1
Enter Setup

B3 and B4 Example: Insert the symbology name and length



Send the symbology name and length before the barcode data from the barcode above. Break up these insertions with spaces. End with a carriage return.

Command string: **B3F42001B4F42001F10D**

B3 is the “Insert symbology name” command

F4 is the “Insert a character multiple times” command

20 is the hex value for a space

01 is the number of time the space character is sent

B4 is the “Insert barcode length” command

F4 is the “Insert a character multiple times” command

20 is the hex value for a space

01 is the number of time the space character is sent

F1 is the “Send all characters” command

0D is the hex value for a CR

The data is output as: **Code128 20 1234567890ABCDEFGHIJ**

<CR>

Move Commands

F5 Move the cursor forward a number of characters

Syntax=F5nn (nn: The numeric value (00-99) for the number of characters the cursor should be moved ahead)

Move the cursor ahead “nn” characters from current cursor position.

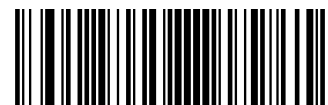

@SETUPE0
** Exit Setup



@SETUPE1
Enter Setup

F5 Example: Move the cursor forward and send the data



1234567890ABCDEFGHIJ

Move the cursor forward 3 characters, then send the rest of the barcode data from the barcode above. End with a carriage return.

Command string: **F503F10D**

F5 is the "Move the cursor forward a number of characters" command

03 is the number of characters to move the cursor

F1 is the "Send all characters" command

0D is the hex value for a CR

The data is output as: **4567890ABCDEFGHIJ**

<CR>

F6 Move the cursor backward a number of characters

Syntax=F6nn (nn: The numeric value (00-99) for the number of characters the cursor should be moved back)

Move the cursor back "nn" characters from current cursor position.

F7 Move the cursor to the beginning

Syntax=F7

Move the cursor to the first character in the input message.

EA Move the cursor to the end

Syntax=EA

Move the cursor to the last character in the input message.



@SETUPE0
**** Exit Setup**



@SETUPE1
Enter Setup

Search Commands

F8 Search forward for a character

Syntax=F8xx (xx: The search character's hex value)

Search the input message forward for "xx" character from the current cursor position, leaving the cursor pointing to the "xx" character.

F8 Example: Send barcode data that starts after a particular character



Search for the letter "D" in barcodes and send all the data that follows, including the "D". Using the barcode above:

Command string: **F844F10D**

F8 is the "Search forward for a character" command

44 is the hex value for "D"

F1 is the "Send all characters" command

0D is the hex value for a CR

The data is output as: **DEFGHIJ**

<CR>

F9 Search backward for a character

Syntax=F9xx(xx: The search character's hex value)

Search the input message backward for "xx" character from the current cursor position, leaving the cursor pointing to the "xx" character.



@SETUPE0
** Exit Setup



@SETUPE1
Enter Setup

B0 Search forward for a string

Syntax=B0nnnnS (nnnn: The string length (up to 9999); S: The ASCII hex value of each character in the string)

Search forward for “S” string from the current cursor position, leaving cursor pointing to “S” string. For example, B0000454657374 will search forward for the first occurrence of the 4-character string “Test.”

B0 Example: Send barcode data that starts after a string of characters



Search for the letters “FGH” in barcodes and send all the data that follows, including “FGH.” Using the barcode above:

Command string: **B00003464748F10D**

B0 is the “Search forward for a string” command

0003 is the string length (3 characters)

46 is the hex value for “F”

47 is the hex value for “G”

48 is the hex value for “H”

F1 is the “Send all characters” command

0D is the hex value for a CR

The data is output as: **FGHIJ**

<CR>

B1 Search backward for a string

Syntax=B1nnnnS (nnnn: The string length (up to 9999); S: The ASCII hex value of each character in the string)

Search backward for “S” string from the current cursor position, leaving cursor pointing to “S” string. For example, B1000454657374 will search backward for the first occurrence of the 4-character string “Test.”



@SETUPE0
** Exit Setup



@SETUPE1
Enter Setup

E6 Search forward for a non-matching character

Syntax=E6xx (xx: The search character's hex value)

Search the input message forward for the first non-"xx" character from the current cursor position, leaving the cursor pointing to the non-"xx" character.

E6 Example: Remove zeros at the beginning of barcode data



This example shows a barcode that has been zero filled. You may want to ignore the zeros and send all the data that follows. E6 searches forward for the first character that is not zero, then sends all the data after, followed by a carriage return. Using the barcode above:

Command string: **E630F10D**

E6 is the "Search forward for a non-matching character" command

30 is the hex value for 0

F1 is the "Send all characters" command

0D is the hex value for a CR

The data is output as: **37692**

<CR>

E7 Search backward for a non-matching character

Syntax=E7xx(xx: The search character's hex value)

Search the input message backward for the first non-"xx" character from the current cursor position, leaving the cursor pointing to the non-"xx" character.



@SETUPE0
** Exit Setup



@SETUPE1
Enter Setup

Miscellaneous Commands

FB Suppress characters

Syntax=FBnnxyy..zz (nn: The numeric value (00-15) for the number of suppressed characters; xyy..zz: The hex value of the characters to be suppressed)

Suppress all occurrences of up to 15 different characters, starting at the current cursor position, as the cursor is advanced by other commands.

FB Example: Remove spaces in barcode data



This example shows a barcode that has spaces in the data. You may want to remove the spaces before sending the data. Using the barcode above:

Command string: **FB0120F10D**

FB is the “Suppress characters” command

01 is the number of the characters to be suppressed

20 is the hex value for a space

F1 is the “Send all characters” command

0D is the hex value for a CR

The data is output as: **34567890**

<CR>

E4 Replace characters

Syntax = E4nnxx₁xx₂yy₁yy₂...zz₁zz₂(nn: The total count of the number of characters (characters to be replaced plus replacement characters; xx₁: The characters to be replaced, xx₂: The replacement characters, continuing through zz₁ and zz₂)

Replace up to 15 characters in the output message, without moving the cursor.



@SETUPE0
**** Exit Setup**



@SETUPE1
Enter Setup

E4 Example: Replace zeros with CRs in barcode data



If the barcode has characters that the host application does not want included, you can use the E4 command to replace those characters with something else. In this example, you will replace the zeros in the barcode above with carriage returns.

Command string: **E402300DF10D**

E4 is the "Replace characters" command

02 is the total count of characters to be replaced, plus the replacement characters (0 is replaced by CR, so total characters=2)

30 is the hex value for 0

0D is the hex value for a CR (the character that will replace the 0)

F1 is the "Send all characters" command

0D is the hex value for a CR

The data is output as: **1234**

5678

ABC

<CR>

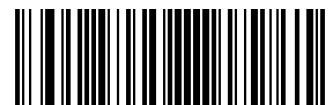

@SETUPE0
** Exit Setup



@SETUPE1
Enter Setup

BA Replace a string with another

Syntax = BAnnNFM510SS₁NN₂SS₂

nn: The count of replacements to be made, if nn=00 or nn>=the number of occurrences of a string to be replaced, then replace all occurrences of that string.

NFM510: The length of the string to be replaced, NFM510>0.

SS₁: The ASCII hex value of each character in the string to be replaced.

NN₂: The length of replacement string, NN₂>=0. To replace string "SS₁" with NUL (i.e. delete string "SS₁"), you should set NN₂ to 00 and leave out SS₂.

SS₂: The ASCII hex value of each character in the replacement string.

From the current cursor position, search forward for the occurrence of "SS₁" string (of length "NFM510") and replace the string with "SS₂" string (of length "NN₂") in the output message until every "SS₁" string is replaced or the count of replacements made reaches "nn" times, without moving the cursor.

BA Example: Replace "23"s with "ABC"s in barcode data



cd123abc23bc12ab232

If the barcode has a string of characters that the host application does not want included, you can use the BA command to replace the string with something else. In this example, you will replace the "23"s in the barcode above with "ABC"s.

Command string: **BA0002323303414243F100**

BA is the "Replace a string with another" command

00 is the count of replacements to be made, 00 means to replace all occurrences of that string

02 is the length of the string to be replaced



@SETUPE0
** Exit Setup



@SETUPE1
Enter Setup

32 is the hex value for 2 (character in the string to be replaced)

33 is the hex value for 3 (character in the string to be replaced)

03 is the length of the replacement string

41 is the hex value for A (character in the replacement string)

42 is the hex value for B (character in the replacement string)

43 is the hex value for C (character in the replacement string)

F1 is the "Send all characters" command

00 is the hex value for a NUL

The data is output as: **cd1ABCabcABCbc12abABC2**

BA Example: Remove only the first occurrence of "23"s in barcode data

If the barcode has a string of characters that the host application wants removed, you can use the BA command to replace the string with NUL. In this example, you will remove the first occurrence of "23" in the barcode above.

Command string: **BA0102323300F100**

BA is the "Replace a string with another" command

01 is the count of replacements to be made

02 is the length of the string to be replaced

32 is the hex value for 2 (character in the string to be replaced)

33 is the hex value for 3 (character in the string to be replaced)

00 is the length of the replacement string, 00 means to replace the string to be replaced with NUL

F1 is the "Send all characters" command

00 is the hex value for a NUL

The data is output as: **cd1abc23bc12ab232**



@SETUPE0
** Exit Setup



@SETUPE1
Enter Setup

EF Insert a delay

Syntax=EFnnnn (nnnn: The delay in 5ms increments, up to 9999)

Inserts a delay of up to 49,995 milliseconds (in multiples of 5), starting from the current cursor position.

EF Example: Insert a delay of 1s between the 5th and 6th character

Send the first 5 characters in a barcode, wait for 1s, then send the rest of the barcode data.

Command string: **F20500EF0200E900**

F2 is the "Send a number of characters" command

05 is the number of characters to send

00 is the hex value for a Null character

EF is the "Insert a delay" command

0200 is the delay value (5msX200=1000ms=1s)

E9 is the "Send all but the last characters" command

00 is the number of characters that will not be sent at the end of the message



@SETUPE0
**** Exit Setup**



@SETUPE1
Enter Setup

B5 Insert key strokes

Syntax=B5nnssxx (nn: The number of keys pressed (without key modifiers); ss: the key modifier from the table below; xx: the key number from the “Unicode Key Maps” in Appendix.)

Insert a key stroke or combination of key strokes. Key strokes are dependent on your keyboard (see the “Unicode Key Maps” in Appendix).

| Key Modifiers | |
|-----------------|----|
| No Key Modifier | 00 |
| Shift Left | 01 |
| Shift Right | 02 |
| Alt Left | 04 |
| Alt Right | 08 |
| Control Left | 10 |
| Control Right | 20 |

For example, B501001F inserts an “a” on a U.S. style keyboard. B5 = the command, 01 = number of keys pressed (without the key modifier), 00 is No Key Modifier, and 1F is the “a” key. If an “A” were to be inserted, B501011F or B501021F would be entered.

If there are two keystrokes, the syntax would change from Syntax=B5nnssxx for one keystroke to Syntax=B5nnssxxssxx. An example that would insert “aA” is as follows: B502001F011F.

Note: Key modifiers can be added together when needed. Example: Shift Left + Alt Left + Control Left =15.



@SETUPE0
** Exit Setup



@SETUPE1
Enter Setup

Chapter 12 Prefix & Suffix

Introduction

A 1D barcode could contain digits, letters, symbols, etc. A 2D barcode could contain more data, such as Chinese characters and other multi-byte characters. However, in real applications, they do not and should not have all information we need, such as barcode type, data acquisition time and delimiter, in order to keep the barcodes short and flexible.

Prefix and suffix are how to fulfill the needs mentioned above. They can be added, removed and modified while the original barcode data remains intact.



Barcode processing procedure:

1. Edit data with Data Formatter
2. Append prefix/suffix
3. Pack data
4. Append terminating character



@SETUPE0
** Exit Setup



@SETUPE1
Enter Setup

Global Settings

Enable/Disable All Prefixes/Suffixes

Disable All Prefixes/Suffixes: Transmit barcode data with no prefix/suffix.

Enable All Prefixes/Suffixes: Allow to append Code ID prefix, AIM ID prefix, custom prefix/suffix and terminating character to the barcode data before the transmission.



@APSENA0
Disable All Prefixes/Suffixes



@APSENA1
Enable All Prefixes/Suffixes

Prefix Sequence



@PRESEQ0
Code ID+ Custom +AIM ID



@PRESEQ1
Custom + Code ID + AIM ID



@SETUPE0
**** Exit Setup**



@SETUPE1
Enter Setup

Custom Prefix

Enable/Disable Custom Prefix

If custom prefix is enabled, you are allowed to append to the data a user-defined prefix that cannot exceed 10 characters. For example, if the custom prefix is “AB” and the barcode data is “123”, the Host will receive “AB123”.



@CPRENA0
Disable Custom Prefix



@CPRENA1
Enable Custom Prefix

Set Custom Prefix

To set a custom prefix, scan the **Set Custom Prefix** barcode then the numeric barcodes corresponding to the hexadecimal value of a desired prefix then the **Save** barcode.

Note: A custom prefix cannot exceed 10 characters.



@CPRSET
Set Custom Prefix



Set the custom prefix to “CODE” (HEX: 0x43/0x4F/0x44/0x45):

1. Scan the **Enter Setup** barcode.
2. Scan the **Set Custom Prefix** barcode.
3. Scan the numeric barcodes “4”, “3”, “4”, “F”, “4”, “4”, “4” and “5” from the “Digit Barcodes” section in Appendix.
4. Scan the **Save** barcode from the “Save/Cancel Barcodes” section in Appendix.
5. Scan the **Enable Custom Prefix** barcode.
6. Scan the **Exit Setup** barcode.



@SETUPE0
** Exit Setup



@SETUPE1

Enter Setup

AIM ID Prefix

AIM (Automatic Identification Manufacturers) ID defines symbology identifier (For the details, see the “AIM ID Table” section in Appendix). If AIM ID prefix is enabled, the scanner will add the symbology identifier before the scanned data after decoding.



@AIDENA0

Disable AIM ID Prefix



@AIDENA1

Enable AIM ID Prefix



AIM ID is not user programmable.



@SETUPE0

**** Exit Setup**



@SETUPE1
Enter Setup

Code ID Prefix

Code ID can also be used to identify barcode type. Unlike AIM ID, Code ID is user programmable. Code ID can only consist of one or two English letters.



@CIDENA0
Disable Code ID Prefix



@CIDENA1
Enable Code ID Prefix

Restore All Default Code IDs

For the information of default Code IDs, see the “Code ID Table” section in Appendix.



@CIDDEF
Restore All Default Code IDs



@SETUPE0
**** Exit Setup**



@SETUPE1
Enter Setup

Modify Code ID

See the examples below to learn how to modify a Code ID and restore the default Code IDs of all symbologies.



Modify PDF417 Code ID to be “p” (HEX: 0x70):

1. Scan the **Enter Setup** barcode.
2. Scan the **Modify PDF417 Code ID** barcode.
3. Scan the numeric barcodes “7” and “0” from the “Digit Barcodes” section in Appendix.
4. Scan the **Save** barcode from the “Save/Cancel Barcodes” section in Appendix.
5. Scan the **Exit Setup** barcode.

Restore the default Code IDs of all symbologies:

1. Scan the **Enter Setup** barcode.
2. Scan the **Restore All Default Code IDs** barcode.
3. Scan the **Exit Setup** barcode.

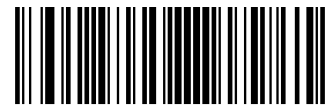

@SETUPE0
**** Exit Setup**



@SETUPE1
Enter Setup

1D symbologies:



@CID002
Modify Code 128 Code ID



@CID004
Modify EAN-8 Code ID



@CID006
Modify UPC-E Code ID



@CID008
Modify Interleaved 2 of 5 Code ID



@CID003
Modify GS1-128 Code ID



@CID005
Modify EAN-13 Code ID



@CID007
Modify UPC-A Code ID

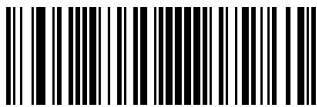

@SETUPE0
**** Exit Setup**



@SETUPE1
Enter Setup



@CID013
Modify Code 39 Code ID



@CID015
Modify Codabar Code ID



@CID017
Modify Code 93 Code ID

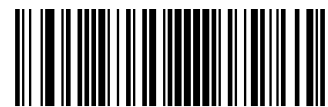

@SETUPE0
**** Exit Setup**



@SETUPE1
Enter Setup

Custom Suffix

Enable/Disable Custom Suffix

If custom suffix is enabled, you are allowed to append to the data a user-defined suffix that cannot exceed 10 characters. For example, if the custom suffix is “AB” and the barcode data is “123”, the Host will receive “123AB”.



@CSUENA0
Disable Custom Suffix



@CSUENA1
Enable Custom Suffix

Set Custom Suffix

To set a custom suffix, scan the **Set Custom Suffix** barcode then the numeric barcodes corresponding to the hexadecimal value of a desired suffix then the **Save** barcode.

Note: A custom suffix cannot exceed 10 characters.



@CSUSET
Set Custom Suffix



Set the custom suffix to “CODE” (HEX: 0x43/0x4F/0x44/0x45):

1. Scan the **Enter Setup** barcode.
2. Scan the **Set Custom Suffix** barcode.
3. Scan the numeric barcodes “4”, “3”, “4”, “F”, “4”, “4”, “4” and “5” from the “Digit Barcodes” section in Appendix.
4. Scan the **Save** barcode from the “Save/Cancel Barcodes” section in Appendix.
5. Scan the **Enable Custom Suffix** barcode.
6. Scan the **Exit Setup** barcode.



@SETUPE0
** Exit Setup



@SETUPE1
Enter Setup

Data Packing

Introduction

Data packing is designed for a specific group of users who want to have the data packed before transmission. Data packing influences data format, so it is advised to disable this feature when it is not required.

Data Packing Options

- ✧ **Disable Data Packing:** Transmit decoded data in raw format (unpacked).
- ✧ **Enable Data Packing, Format 1:** Transmit decoded data with the packet format 1 defined below.
Packet format 1: [STX + ATTR + LEN] + [AL_TYPE + DATA] + [LRC]
STX: 0x02
ATTR: 0x00
LEN: Barcode data length is expressed in 2 bytes ranging from 0x0000 (0) to 0xFFFF (65535).
AL_TYPE: 0x36
DATA: Raw barcode data.
LRC: Check digit.
LRC calculation algorithm: computation sequence: 0xFF+LEN+AL_TYPE+DATA; computation method is XOR, byte by byte.
- ✧ **Enable Data Packing, Format 2:** Transmit decoded data with the packet format 2 defined below.
Packet format 2: [STX + ATTR + LEN] + [AL_TYPE] + [Symbology_ID + DATA] + [LRC]
STX: 0x02
ATTR: 0x00
LEN: Barcode data length is expressed in 2 bytes ranging from 0x0000 (0) to 0xFFFF (65535).
AL_TYPE: 0x3B
Symbology_ID: The ID number of symbology, 1 byte.
DATA: Raw barcode data.
LRC: Check digit.
LRC calculation algorithm: computation sequence: 0xFF+LEN+AL_TYPE+Symbology_ID+DATA; computation method is XOR, byte by byte.



@SETUPE0
** Exit Setup



@SETUPE1

Enter Setup



@PACKAG0

Disable Data Packing



@PACKAG1

Enable Data Packing, Format 1



@PACKAG2

Enable Data Packing, Format 2



@SETUPE0

**** Exit Setup**



@SETUPE1
Enter Setup

Terminating Character Suffix

Enable/Disable Terminating Character Suffix

A terminating character such as carriage return (CR) or carriage return/line feed pair (CRLF) can only be used to mark the end of data, which means nothing can be added after it.



@TSUENA0

Disable Terminating Character Suffix



@TSUENA1

Enable Terminating Character Suffix

Set Terminating Character Suffix

To set a terminating character suffix, scan the **Set Terminating Character Suffix** barcode then the numeric barcodes corresponding to the hexadecimal value of a desired terminating character then the **Save** barcode.

Note: A terminating character suffix cannot exceed 2 characters.



@TSUSET

Set Terminating Character Suffix

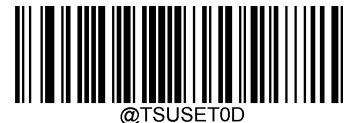

@TSUSET0D

Set Terminating Character to CR (0x0D)

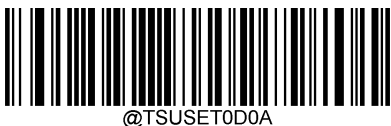

@TSUSET0D0A

Set Terminating Character to CRLF (0x0D,0x0A)



@SETUPE0

**** Exit Setup**



@SETUPE1

Enter Setup



Set the terminating character suffix to 0x0A:

1. Scan the **Enter Setup** barcode.
2. Scan the **Set Terminating Character Suffix** barcode.
3. Scan the numeric barcodes "0" and "A" from the "Digit Barcodes" section in Appendix.
4. Scan the **Save** barcode from the "Save/Cancel Barcodes" section in Appendix.
5. Scan the **Enable Terminating Character Suffix** barcode.
6. Scan the **Exit Setup** barcode.



@SETUPE0

**** Exit Setup**



@SETUPE1
Enter Setup

Chapter 13 Programming Commands

Use of Programming Command

Besides the barcode programming method, the scanner can also be configured by serial commands (HEX) sent from the host device. **All commands must be entered in uppercase letters.**

Query Commands

For query commands, the entry in the **Data** field in the syntax above is one of the following characters means:

- * (HEX: **2A**) What is the scanner's current value for the setting(s).
- & (HEX: **26**) What is the factory default value for the setting(s).
- ^ (HEX: **5E**) What is the range of possible values for the setting(s).

The value of the **StoreType** field in a query command can be either "@" (HEX: **40**) or "#" (HEX: **23**).

A query command with the **SubTag** field omitted means to query all the settings concerning a tag. For example, to query all the current settings about Code 11, you should enter **7E 01 30 30 30 30 40 43 31 31 2A 3B 03** (i.e. ~<SOH>0000@C11*;<ETX>).

Command Syntax

Prefix StorageType Tag SubTag {Data} [,SubTag {Data}] [:Tag SubTag {Data}] [...] Suffix

Prefix: "~<SOH>0000" (HEX: **7E 01 30 30 30 30**), 6 characters.

StorageType: "@" (HEX: **40**) or "#" (HEX: **23**), 1 character. "@" means permanent setting which will not be lost by removing power from the scanner or rebooting it; "#" means temporary setting which will be lost by removing power from the scanner or rebooting it.

Tag: A 3-character case-sensitive field that identifies the desired command group.

SubTag: A 3-character case-sensitive field that identifies the desired parameter within the tag group. For example, the SubTag for the keyboard layout is CTY.

Data: The value for a feature or parameter setting, identified by the Tag and SubTag.

Suffix: ";<ETX>" (HEX: **3B 03**), 2 characters.

Multiple commands can be issued within one Prefix/Suffix sequence. For configuration commands, only the **Tag**, **SubTag**,



@SETUPE0
** Exit Setup



@SETUPE1
Enter Setup

and **Data** fields must be repeated for each command in sequence. If an additional command is to be applied to the same Tag, then the command is separated with a comma (,) and only the **SubTag** and **Data** fields of the additional commands are issued. If the additional command requires a different **Tag** field, the command is separated from previous command by a semicolon (;).



If you need to configure the scanner by serial commands sent from the host device in real time, it is recommended to use the temporary setting with Storage as '#'. The permanent setting with Storage as '@' involves erasing and writing process, which will affect the service life of the flash memory.

Responses

Different from command sequence, the prefix of a response consists of the six characters of "<STX><SOH>0000" (HEX: **02 01 30 30 30 30**).

The scanner responds to serial commands with one of the following three responses:

- <ACK> (HEX: **06**) Indicates a good command which has been processed.
- <NAK> (HEX: **15**) Indicates a good configuration command with its **Data** field entry out of the allowable range for this Tag and SubTag combination (e.g. an entry for an inter-keystroke delay of 100 when the field will only allow 2 digits), or an invalid query command.
- <ENQ> (HEX: **05**) Indicates an invalid Tag or SubTag command.

When responding, the scanner echoes back the command sequence with the status character above inserted directly before each of the punctuation marks (the comma or semicolon) in the command.

Examples

Example 1: Enable Code 11, set the minimum and maximum lengths to 12 and 22 respectively.

Enter: **7E 01 30 30 30 30 40 43 31 31 45 4E 41 31 2C 4D 49 4E 31 32 2C 4D 41 58 32 32 3B 03**
 (~<SOH>0000@C11ENA1,MIFM5102,MAX22;<ETX>)

Response: **02 01 30 30 30 30 40 43 31 31 45 4E 41 31 06 2C 4D 49 4E 31 32 06 2C 4D 41 58 32 32 06 3B 03**
 (<STX><SOH>0000@C11ENA1<ACK>,MIFM5102<ACK>,MAX22<ACK>;<ETX>)

Example 2: Query the current minimum and maximum lengths of Code 11.



@SETUPE0
**** Exit Setup**



@SETUPE1
Enter Setup

Enter: **7E 01 30 30 30 30 40 43 31 31 4D 49 4E 2A 2C 4D 41 58 2A 3B 03**
(~<SOH>0000@C11MIN*,MAX*;<ETX>)

Response: **02 01 30 30 30 30 40 43 31 31 4D 49 4E 31 32 06 2C 4D 41 58 32 32 06 3B 03**
(<STX><SOH>0000@C11MIFM5102<ACK>,MAX22<ACK>;<ETX>)

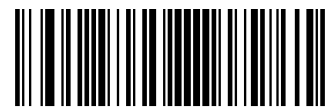

@SETUPE0
** Exit Setup



@SETUPE1
Enter Setup

Read Barcode On/Off

Sending the Read Barcode Off command `~<SOH>0000#SCNENA0;<ETX>` to the scanner can disable it from reading barcode, and the scanner is unable to scan barcode unless you send the Read Barcode On command `~<SOH>0000#SCNENA1;<ETX>` to it or power cycle it. By default, Read Barcode is On.

Turn On Good Read LED

You may turn on the external Good Read LED of the scanner for a certain period of time with a command sent from the host. Note that the scanner **cannot** scan barcodes when it is executing this command. The duration is from 10 to 10000ms.

Command for querying whether the scanner supports this feature: LEDONS* or LEDONS&

Returning LEDONS<ACK> indicates the scanner supports this feature.

Command for querying the range of possible values for the setting: LEDONS^

Returning LEDONS-2C10-10000D <ACK> indicates the range for the length of time the LED stays lit is 10-10000ms.

Example: Turn on the Good Read LED for 1,000ms

Enter: `~<SOH>0000#LEDONS2C1000D;<ETX>`

Response: `<STX><SOH>0000#LEDONS2C1000D<ACK>;<ETX>`

Turn On Illumination LED

You may turn on the internal illumination LED on the scanner for a certain period of time with a command sent from the host. Note that the scanner **cannot** scan barcodes when it is executing this command. The duration is from 10 to 10000ms.

Command for querying whether the scanner supports this feature: LEDONI* or LEDONI&

Returning LEDONI<ACK> indicates the scanner supports this feature.

Command for querying the range of possible values for the setting: LEDONI^

Returning LEDONI-0C10-10000D <ACK> indicates the range for the length of time the LED stays lit is 10-10000ms.

Example: Turn on the illumination LED for 1,000ms

Enter: `~<SOH>0000#LEDONI0C1000D;<ETX>`

Response: `<STX><SOH>0000#LEDONI0C1000D<ACK>;<ETX>`



@SETUPE0
** Exit Setup



@SETUPE1
Enter Setup

Chapter 14 Batch Programming

Introduction

Batch programming enables users to integrate a batch of commands into a single batch barcode.

Listed below are batch programming rules:

1. Command format: Command + Parameter Value.
2. Each command is terminated by a semicolon (;). Note that there is no space between a command and its terminator semicolon.
3. Use the barcode generator software to generate a 2D batch barcode.

Example: Create a batch barcode for **Illumination Always On, Sense Mode, Decode Session Timeout = 2s**:

1. Input the commands:

@ILLSCN2;SCNMOD2;ORTSET2000;

2. Generate a batch barcode.

When setting up a scanner with the above configuration, scan the **Enable Batch Barcode** barcode and then the batch barcode generated.



@BATCHS
Enable Batch Barcode



@SETUPE0
** Exit Setup



@SETUPE1
Enter Setup

Create a Batch Command

A batch command may contain a number of individual commands each of which is terminated by a semicolon (;).

For more information, refer to the “Use of Programming Command” section in Chapter 3.

Create a Batch Barcode

Batch barcodes can be produced in the format of PDF417, QR Code or Data Matrix.

Example: Create a batch barcode for **Illumination Always On, Sense Mode, Decode Session Timeout = 2s**:

1. Input the following commands:

```
@ILLSCN2;SCNMOD2;ORTSET2000;
```

2. Generate a PDF417 batch barcode.



@SETUPE0
** Exit Setup



@SETUPE1
Enter Setup

Use Batch Barcode

To put a batch barcode into use, scan the following barcodes. (Use the example above.)



@SETUPE1
Enter Setup



@BATCHS
Enable Batch Barcode

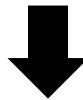

Batch Barcode

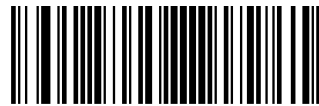
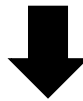

@SETUPE0
Exit Setup



@SETUPE0
** Exit Setup

Appendix

Digit Barcodes

0~9



@DIGIT0

0



@DIGIT2

2



@DIGIT4

4



@DIGIT1

1



@DIGIT3

3



@DIGIT5

5



@DIGIT6

6



@DIGIT7

7



@DIGIT8

8



@DIGIT9

9

A~F



@DIGITA

A



@DIGITB

B



@DIGITC

C



@DIGITD

D



@DIGITE

E



@DIGITF

F

Save/Cancel Barcodes

After reading numeric barcode(s), you need to scan the **Save** barcode to save the data. If you scan the wrong digit(s), you can either scan the **Cancel** barcode and then start the configuration all over again, or scan the **Delete the Last Digit** barcode and then the correct digit, or scan the **Delete All Digits** barcode and then the digits you want.

For instance, after reading the **Maximum Length** barcode and numeric barcodes “1”, “2” and “3”, you scan:

- ✧ **Delete the Last Digit:** The last digit “3” will be removed.
- ✧ **Delete All Digits:** All digits “123” will be removed.
- ✧ **Cancel:** The maximum length configuration will be cancelled. And the scanner is still in the setup mode.



@DIGSAV

Save



@DIGCAN

Cancel



@DIGDEL

Delete the Last Digit



@DIGDAL

Delete All Digits

Factory Defaults Table (MONGO-P_V2.ST.G02.2)

| Parameter | Factory Default | Remark |
|---------------------------------|--|----------------------------|
| System Settings | | |
| Barcode Programming | Disabled (Exit Setup) | |
| Programming Barcode Data | Do not transmit | |
| Scan Mode | Level Mode | |
| Decode Session Timeout | 0ms | 1-3,600,000ms; 0: Infinite |
| Reread Timeout | Enabled, 0ms | 1-3,600,000ms |
| Reread Timeout Reset | Off | |
| Good Read Delay | Disabled, 500ms | 1-3,600,000ms |
| Read Barcode On/Off | On | |
| Bad Read Message | On | |
| | "?" | 1-7 characters |
| Trigger Commands | Disabled | |
| Start Scanning Command | <SOH> T <EOT> | |
| Stop Scanning Command | <SOH> P <EOT> | |
| Illumination | Normal | |
| Good Read LED | On | |
| Good Read LED Duration | 20ms | |
| Security Level | 1 | |
| Enable/Disable Switching Input | Disabled | |
| Trigger Slope | Negative Slope | |
| Trigger Duration | 0ms | 0-60,000ms |
| Debounce Duration | 10ms | 0-250ms |
| Enable/Disable Switching Output | Disabled | |
| Output High/Low Level | Output High Level | |
| Output Duration | 400ms | 0-60,000ms |
| Enable Level Output | Output Level After a Good Read | |
| Stop Level Output | Stop Level Output When Another Decode Session Starts | |
| Default Interface | RS-232 | |
| RS-232 Interface | | |
| Baud Rate | 9600 | |
| Parity Check | None | |

| | | |
|------------------------------------|---|--|
| Data Bits | 8 | |
| Stop Bits | 1 | |
| Symbologies | | |
| Global Settings | | |
| Surround GS1 AI's with Parentheses | Do Not Surround GS1 AI's with Parentheses | |
| Code 128 | | |
| Code 128 | Enabled | |
| Maximum Length | 48 | |
| Minimum Length | 1 | |
| EAN-8 | | |
| EAN-8 | Enabled | |
| Check Character | Transmit | |
| 2-Digit Add-On Code | Disabled | |
| 5-Digit Add-On Code | Disabled | |
| Add-On Code | Not Required | |
| Convert EAN-8 to EAN-13 | Disabled | |
| EAN-13 | | |
| EAN-13 | Enabled | |
| Check Character | Transmit | |
| 2-Digit Add-On Code | Disabled | |
| 5-Digit Add-On Code | Disabled | |
| Add-On Code | Not Required | |
| UPC-E | | |
| UPC-E | Enabled | |
| Check Character | Transmit | |
| 2-Digit Add-On Code | Disabled | |
| 5-Digit Add-On Code | Disabled | |
| Add-On Code | Not Required | |
| Transmit Preamble Character | System Character | |
| Convert UPC-E to UPC-A | Disabled | |
| UPC-A | | |
| UPC-A | Enabled | |
| Check Character | Transmit | |
| 2-Digit Add-On Code | Disabled | |
| 5-Digit Add-On Code | Disabled | |

| | | |
|--------------------------------|------------------|----------------|
| Add-On Code | Not Required | |
| Transmit Preamble Character | System Character | |
| Interleaved 2 of 5 | | |
| Interleaved 2 of 5 | Enabled | |
| Maximum Length | 80 | |
| Minimum Length | 1 | No less than 4 |
| Check Character Verification | Disabled | |
| Code 39 | | |
| Code 39 | Enabled | |
| Maximum Length | 48 | |
| Minimum Length | 1 | |
| Check Character Verification | Disabled | |
| Start/Stop Character | Do not transmit | |
| Code 39 Full ASCII | Disabled | |
| Code 32 Pharmaceutical (PARAF) | Disabled | |
| Code 32 Prefix | Disabled | |
| Code 32 Start/Stop Character | Do not transmit | |
| Code 32 Check Character | Do not transmit | |
| Codabar | | |
| Codabar | Enabled | |
| Maximum Length | 60 | |
| Minimum Length | 2 | |
| Check Character Verification | Disabled | |
| Start/Stop Character | Do not transmit | |
| | ABCD/ABCD | |
| Code 93 | | |
| Code 93 | Disabled | |
| Maximum Length | 48 | |
| Minimum Length | 1 | No less than 1 |
| GS1-128 (UCC/EAN-128) | | |
| GS1-128 | Enabled | |
| Maximum Length | 48 | |
| Minimum Length | 1 | |
| Data Formatter | | |
| Data Formatter | Disabled | |

| | | |
|------------------------------|-------------------------|--|
| Data Format Selection | Format_0 | |
| Prefix & Suffix | | |
| All Prefixes/Suffixes | Disabled | |
| Prefix Sequence | Code ID+ Custom +AIM ID | |
| Custom Prefix | Enabled | |
| AIM ID Prefix | Disabled | |
| Code ID Prefix | Disabled | |
| Custom Suffix | Disabled | |
| Data Packing | Disable Data Packing | |
| Terminating Character Suffix | Enabled (0D 0A) | |

AIM ID Table (V2022.6)

| Symbology | AIM ID | Possible AIM ID Modifiers (m) |
|-----------------------|--------|-------------------------------|
| Code 128 | JC0 | |
| GS1-128 (UCC/EAN-128) | JC1 | |
| EAN-8 | JE4 | |
| EAN-13 | JE0 | |
| EAN-13 with Addon | JE3 | |
| UPC-E | JE0 | |
| UPC-E with Addon | JE3 | |
| UPC-A | JE0 | |
| UPC-A with Addon | JE3 | |
| Interleaved 2 of 5 | JIm | 0, 1, 3 |
| Code 39 | JAm | 0, 1, 3, 4, 5, 7 |
| Codabar | JFm | 0, 1, 2, 4 |
| Code 93 | JG0 | |

Code ID Table (V1.00.0)

| Symbology | Code ID |
|-----------------------|---------|
| Code 128 | j |
| GS1-128 (UCC/EAN-128) | j |
| EAN-8 | d |
| EAN-13 | d |
| UPC-E | c |
| UPC-A | c |
| Interleaved 2 of 5 | e |
| Code 39 | b |
| Codabar | a |
| Code 93 | i |

Symbology ID Number (V1.00.0)

| Symbology | ID Number |
|-----------------------|-----------|
| Code 128 | 002 |
| GS1-128 (UCC/EAN-128) | 003 |
| EAN-8 | 004 |
| EAN-13 | 005 |
| UPC-E | 006 |
| UPC-A | 007 |
| Interleaved 2 of 5 | 008 |
| Code 39 | 013 |
| Codabar | 015 |
| Code 93 | 017 |

ASCII Table

| Hex | Dec | Char |
|-----|-----|-------------------------------|
| 00 | 0 | NUL (Null char.) |
| 01 | 1 | SOH (Start of Header) |
| 02 | 2 | STX (Start of Text) |
| 03 | 3 | ETX (End of Text) |
| 04 | 4 | EOT (End of Transmission) |
| 05 | 5 | ENQ (Enquiry) |
| 06 | 6 | ACK (Acknowledgment) |
| 07 | 7 | BEL (Bell) |
| 08 | 8 | BS (Backspace) |
| 09 | 9 | HT (Horizontal Tab) |
| 0a | 10 | LF (Line Feed) |
| 0b | 11 | VT (Vertical Tab) |
| 0c | 12 | FF (Form Feed) |
| 0d | 13 | CR (Carriage Return) |
| 0e | 14 | SO (Shift Out) |
| 0f | 15 | SI (Shift In) |
| 10 | 16 | DLE (Data Link Escape) |
| 11 | 17 | DC1 (XON) (Device Control 1) |
| 12 | 18 | DC2 (Device Control 2) |
| 13 | 19 | DC3 (XOFF) (Device Control 3) |
| 14 | 20 | DC4 (Device Control 4) |
| 15 | 21 | NAK (Negative Acknowledgment) |
| 16 | 22 | SYN (Synchronous Idle) |
| 17 | 23 | ETB (End of Trans. Block) |
| 18 | 24 | CAN (Cancel) |
| 19 | 25 | EM (End of Medium) |
| 1a | 26 | SUB (Substitute) |
| 1b | 27 | ESC (Escape) |
| 1c | 28 | FS (File Separator) |
| 1d | 29 | GS (Group Separator) |

| Hex | Dec | Char |
|-----|-----|--------------------------------|
| 1e | 30 | RS (Request to Send) |
| 1f | 31 | US (Unit Separator) |
| 20 | 32 | SP (Space) |
| 21 | 33 | ! (Exclamation Mark) |
| 22 | 34 | " (Double Quote) |
| 23 | 35 | # (Number Sign) |
| 24 | 36 | \$ (Dollar Sign) |
| 25 | 37 | % (Percent) |
| 26 | 38 | & (Ampersand) |
| 27 | 39 | ` (Single Quote) |
| 28 | 40 | ((Left/ Opening Parenthesis) |
| 29 | 41 |) (Right/ Closing Parenthesis) |
| 2a | 42 | * (Asterisk) |
| 2b | 43 | + (Plus) |
| 2c | 44 | , (Comma) |
| 2d | 45 | - (Minus/ Dash) |
| 2e | 46 | . (Dot) |
| 2f | 47 | / (Forward Slash) |
| 30 | 48 | 0 |
| 31 | 49 | 1 |
| 32 | 50 | 2 |
| 33 | 51 | 3 |
| 34 | 52 | 4 |
| 35 | 53 | 5 |
| 36 | 54 | 6 |
| 37 | 55 | 7 |
| 38 | 56 | 8 |
| 39 | 57 | 9 |
| 3a | 58 | : (Colon) |
| 3b | 59 | ; (Semi-colon) |
| 3c | 60 | < (Less Than) |
| 3d | 61 | = (Equal Sign) |

| Hex | Dec | Char |
|-----|-----|----------------------------|
| 3e | 62 | > (Greater Than) |
| 3f | 63 | ? (Question Mark) |
| 40 | 64 | @ (AT Symbol) |
| 41 | 65 | A |
| 42 | 66 | B |
| 43 | 67 | C |
| 44 | 68 | D |
| 45 | 69 | E |
| 46 | 70 | F |
| 47 | 71 | G |
| 48 | 72 | H |
| 49 | 73 | I |
| 4a | 74 | J |
| 4b | 75 | K |
| 4c | 76 | L |
| 4d | 77 | M |
| 4e | 78 | N |
| 4f | 79 | O |
| 50 | 80 | P |
| 51 | 81 | Q |
| 52 | 82 | R |
| 53 | 83 | S |
| 54 | 84 | T |
| 55 | 85 | U |
| 56 | 86 | V |
| 57 | 87 | W |
| 58 | 88 | X |
| 59 | 89 | Y |
| 5a | 90 | Z |
| 5b | 91 | [(Left/ Opening Bracket) |
| 5c | 92 | \ (Back Slash) |
| 5d | 93 |] (Right/ Closing Bracket) |

| Hex | Dec | Char |
|-----|-----|--------------------------|
| 5e | 94 | ^ (Caret/ Circumflex) |
| 5f | 95 | _ (Underscore) |
| 60 | 96 | ' (Grave Accent) |
| 61 | 97 | a |
| 62 | 98 | b |
| 63 | 99 | c |
| 64 | 100 | d |
| 65 | 101 | e |
| 66 | 102 | f |
| 67 | 103 | g |
| 68 | 104 | h |
| 69 | 105 | i |
| 6a | 106 | j |
| 6b | 107 | k |
| 6c | 108 | l |
| 6d | 109 | m |
| 6e | 110 | n |
| 6f | 111 | o |
| 70 | 112 | p |
| 71 | 113 | q |
| 72 | 114 | r |
| 73 | 115 | s |
| 74 | 116 | t |
| 75 | 117 | u |
| 76 | 118 | v |
| 77 | 119 | w |
| 78 | 120 | x |
| 79 | 121 | y |
| 7a | 122 | z |
| 7b | 123 | { (Left/ Opening Brace) |
| 7c | 124 | (Vertical Bar) |
| 7d | 125 | } (Right/ Closing Brace) |
| 7e | 126 | ~ (Tilde) |
| 7f | 127 | DEL (Delete) |

Unicode Key Maps

| | | | | | | | | | | | | | | | | | | | | |
|----|----|----|----|----|----|----|----|----|----|----|----|----|----|----|----|----|----|----|----|----|
| 6E | 70 | 71 | 72 | 73 | 74 | 75 | 76 | 77 | 78 | 79 | 7A | 7B | 7C | 7D | 7E | • | • | • | | |
| 01 | 02 | 03 | 04 | 05 | 06 | 07 | 08 | 09 | 0A | 0B | 0C | 0D | 0F | 4B | 50 | 55 | 5A | 5F | 64 | 69 |
| 10 | 11 | 12 | 13 | 14 | 15 | 16 | 17 | 18 | 19 | 1A | 1B | 1C | 1D | 4C | 51 | 56 | 5B | 60 | 65 | 6A |
| 1E | 1F | 20 | 21 | 22 | 23 | 24 | 25 | 26 | 27 | 28 | 29 | 2B | | | | 5C | 61 | 66 | | |
| 2C | 2E | 2F | 30 | 31 | 32 | 33 | 34 | 35 | 36 | 37 | 39 | | | 53 | | | 5D | 62 | 67 | 6C |
| 3A | 3B | 3C | 3D | | | | | 3E | 3F | 38 | 40 | 4F | 54 | 59 | 63 | 68 | | | | |

104 Key U.S. Style Keyboard

| | | | | | | | | | | | | | | | | | | | | |
|----|----|----|----|----|----|----|----|----|----|----|----|----|----|----|----|----|----|----|----|----|
| 6E | 70 | 71 | 72 | 73 | 74 | 75 | 76 | 77 | 78 | 79 | 7A | 7B | 7C | 7D | 7E | • | • | • | | |
| 01 | 02 | 03 | 04 | 05 | 06 | 07 | 08 | 09 | 0A | 0B | 0C | 0D | 0F | 4B | 50 | 55 | 5A | 5F | 64 | 69 |
| 10 | 11 | 12 | 13 | 14 | 15 | 16 | 17 | 18 | 19 | 1A | 1B | 1C | 2B | 4C | 51 | 56 | 5B | 60 | 65 | 6A |
| 1E | 1F | 20 | 21 | 22 | 23 | 24 | 25 | 26 | 27 | 28 | 29 | 1D | | | | 5C | 61 | 66 | | |
| 2C | 2D | 2E | 2F | 30 | 31 | 32 | 33 | 34 | 35 | 36 | 37 | 39 | | 53 | | | 5D | 62 | 67 | 6C |
| 3A | 3B | 3C | 3D | | | | | 3E | 3F | 38 | 40 | 4F | 54 | 59 | 63 | 68 | | | | |

105 Key European Style Keyboard

Newland EMEA
+ 31 (0) 345 87 00 33
info@newland-id.com

Rolweg 25
4104 AV Culemborg
The Netherlands

Need more info?
Contact us or one of our partners at
newland-id.com/contact

